

A graphical user interface for stand-alone and mixed-type modelling of reinforced concrete structures

Vahid Sadeghian^a and Frank Vecchio^{*}

*Department of Civil Engineering, University of Toronto, 35 St. George St.,
Toronto, ON, Canada M5S 1A4*

(Received December 5, 2014, Revised July 9, 2015, Accepted July 20, 2015)

Abstract. FormWorks-Plus is a generalized public domain user-friendly preprocessor developed to facilitate the process of creating finite element models for structural analysis programs. The lack of a graphical user interface in most academic analysis programs forces users to input the structural model information into the standard text files, which is a time-consuming and error-prone process. FormWorks-Plus enables engineers to conveniently set up the finite element model in a graphical environment, eliminating the problems associated with conventional input text files and improving the user's perception of the application. In this paper, a brief overview of the FormWorks-Plus structure is presented, followed by a detailed explanation of the main features of the program. In addition, demonstration is made of the application of FormWorks-Plus in combination with VecTor programs, advanced nonlinear analysis tools for reinforced concrete structures. Finally, aspects relating to the modelling and analysis of three case studies are discussed: a reinforced concrete beam-column joint, a steel-concrete composite shear wall, and a SFRC shear panel. The unique mixed-type frame-membrane modelling procedure implemented in FormWorks-Plus can address the limitations associated with most frame type analyses.

Keywords: graphical user interface; finite element method; computer aided simulation; computer applications; structural models; nonlinear analysis

1. Introduction

As structural analysis software becomes more advanced, and the demands and expectations to accurately assess the response of structures increase, more detailed and sophisticated finite element models are required. In the past, structural analysis programs usually forced the user to input analysis parameters including nodal coordinates, elements, support restraints, applied loads, and analysis options manually using text files with specific formats. This was a time consuming and frustrating process that required high levels of expertise. Novice users had to spend significant amounts of time to become familiar with the naming conventions of different variables and with the input format of the files. In addition, it was typically challenging to trace back errors or false

^{*} Corresponding author, Professor, E-mail: fjv@ecf.utoronto.ca

^a Ph.D. candidate, E-mail: vahid.sadeghian@utoronto.ca

input data since the user was not able to visualize the model.

In recent years, with significant improvements in computer science, especially in the area of software application programming for human-computer interaction, new display and interface design techniques were developed resulting in Graphical User Interface (GUI) programs. GUIs enable the user to interact with the computer through graphical icons, toolbars, buttons, and other user-friendly tools. Enhancing the structural analysis software with a GUI allows engineers to conveniently set up finite element models in a graphical workspace and facilitates the process of selecting the analysis options, thus reducing the possibility of errors and saving time. One of the major reasons that some commercial structural software gain wide recognition among engineers is that, unlike most academic software, they provide user-friendly GUI in addition to the analysis program. A good GUI reduces the software training cost noticeably which can be one to three times the cost of the actual software (Bakewell 1993). It also improves the user's perception of the application. Although some academic structural programs have advanced analysis methods and can be very reliable, the lack of a good GUI coupled with a complex modelling procedure may result in the software being ignored by the potential users; its practical capabilities will not be embraced and exploited by the engineering community.

The VecTor suite of programs was developed at the University of Toronto to analyze a wide range of reinforced concrete (RC) structure types. The programs are based on a secant stiffness formulation using a total-load iterative approach, and employ a smeared crack procedure. The theoretical basis of VecTor programs is the Modified Compression Field Theory (MCFT) (Vecchio and Collins 1986) and the Disturbed Stress Field Model (DSFM) (Vecchio 2000). The MCFT and DSFM have been shown to be capable of accurately representing the behaviour of RC, particularly under shear-critical conditions. Several experimental programs with different types of specimens have been undertaken at the University of Toronto and elsewhere to verify the accuracy of the programs. In addition, analyzing real-world structures including frames, slabs, shear walls, silos, bridges, offshore platforms, crash barriers, and nuclear containment structures have been demonstrated the utility of the VecTor programs in determining the complex nonlinear behaviour of concrete structures (Selby *et al.* 1997, Palermo and Vecchio 2002, Vecchio and Shim 2004). Although these nonlinear finite element programs are originally designed for analysis of RC structures, in recent years their application has been extended to other material types including structural steel, masonry and wood.

A user-friendly GUI is required for the entire suite of VecTor programs if they are to be of greater use to design engineers. The lack of a GUI forces users to create the finite element model in text files with specific formats which is a challenging and time-consuming process. A pre-processor would aid in creating appropriate structural models, inputting and checking data, selecting proper analysis parameters, and specifying appropriate loads. In addition, its graphing capabilities would allow the user to see the structure from different views, cut various sections and permit a wide range of plots to demonstrate the structure shape, material specifications and applied loads.

While most of the available GUIs were developed to model structures for design purposes, there are a few which were specifically developed to facilitate the analysis of structures. However, none are sufficiently suitable for modelling RC structures in detail to the extent necessary for advanced analyses. To fully consider the nonlinear behaviour of RC, a new type of GUI is required which provides the user with a wide range of material models and element types which are specifically designed for analyzing cracked RC. For example, to consider slip between reinforcement and concrete, bond-slip elements are required which serve as a deformable interface

between the concrete elements and reinforcement elements. The VecTor programs include two types of bond-slip elements: the link element and the contact element. Also in analyzing RC structures, there are two common approaches to modelling the reinforcement: either smeared or discrete. Each approach is suitable for a particular type of problem; thus, a GUI is required that is capable of modelling the reinforcement in both manners. In addition, in recent years there has been a substantial interest in modelling repaired RC structures. Several types of repair strategies have been developed such as using FRP sheets and steel jacketing. Each method requires different input parameters and material models. Also, the repair material can debond from the surface of the concrete. To capture this phenomenon and other local behaviours, a more complicated FE model is required. A GUI which can facilitate the modelling process of the repaired structures will help engineers to save time and reduce the likelihood of errors.

In this study a new extended version of FormWorks, FormWorks-Plus, was developed which gives the user better modelling capabilities and is more user-friendly. In addition, FormWorks-Plus is compatible with remaining types of structures and supports a wide range of element and material types. This paper intends to first explain the architecture of the program and fundamental C++ classes employed, followed by a detailed description of the main features of the program including available material and element types, different viewing capabilities, auto-meshing feature, and auto-substructuring feature. Finally, to illustrate the application of the program the modelling process and analysis results of three case studies are described.

Both VecTor and FormWorks-Plus are public domain programs and can be downloaded free from the VecTor group website (www.civ.utoronto.ca/vector).

2. Background

The FormWorks-Plus program was written in the C++ programming language using Microsoft Foundation Classes (MFC), and compiled with Microsoft Visual C++ Version 9.0. The MFC classes are a set of predefined classes which provide a standard Application Programming Interface (API) for development of Windows applications. These classes are based on an object-oriented approach which is a method of organizing groups of data and operations in different set of objects. MFC objects or objects of classes derived from MFC can be created and used to develop Windows applications like GUIs. The member functions of these MFC-based classes allow communication with Windows, processing Windows messages, and interaction between classes.

The architecture of the FormWorks-Plus application consists of two main classes known as a document and a view. The document is responsible for collecting and processing all the data in the application with which the user interacts, while the view is an object that provides different methods to display all or part of the data stored in a document. The separation of document and view classes enables the application to have multiple views of the same document.

The document/view structure of FormWorks-Plus contains instances of several major classes: CJobData, CStructureData, CLoadData, CAttributeData, and CWMultiPolygon (Fig. 1). Each of these classes contains instances of smaller classes or utilizes them in data structures. Additionally, the document class (CPr1Doc) contains serialization member functions to save data into memory storage. The view class (CPr1View), among other purposes, contains functions for drawing to the screen, printing, and interacting with the mouse.

To display 2D and 3D structures with complex element shapes and geometries,

FormWorks-Plus is enhanced with OpenGL (Open Graphics Library), an advanced graphical tool. OpenGL is a standard specification defining a cross-platform for writing applications that produce computer graphics. The library provides several functions which can be used to draw complex three-dimensional shapes from the simplest geometric objects that the system can handle. Fig. 2 illustrates various parts of the FormWorks-Plus graphical environment.

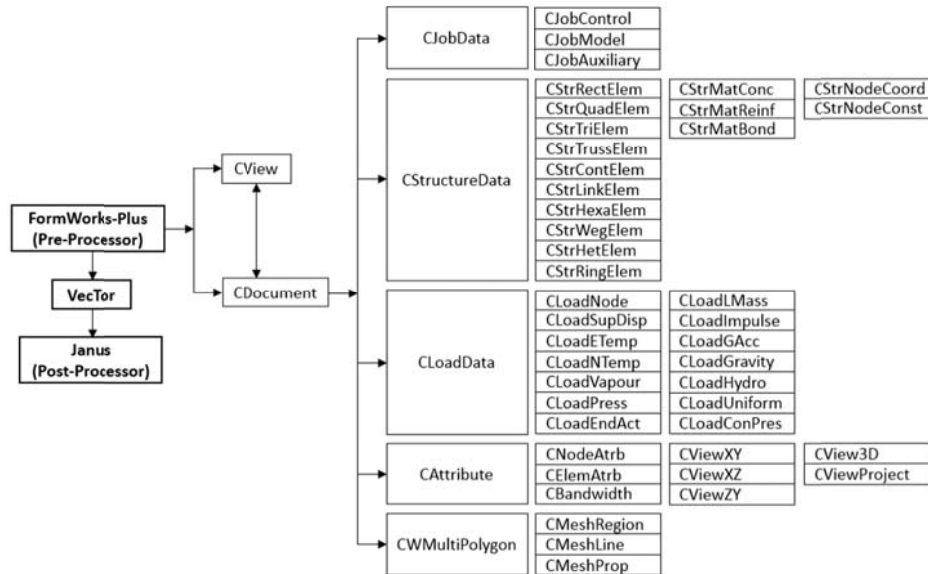

Fig. 1 FormWorks-Plus source code structure

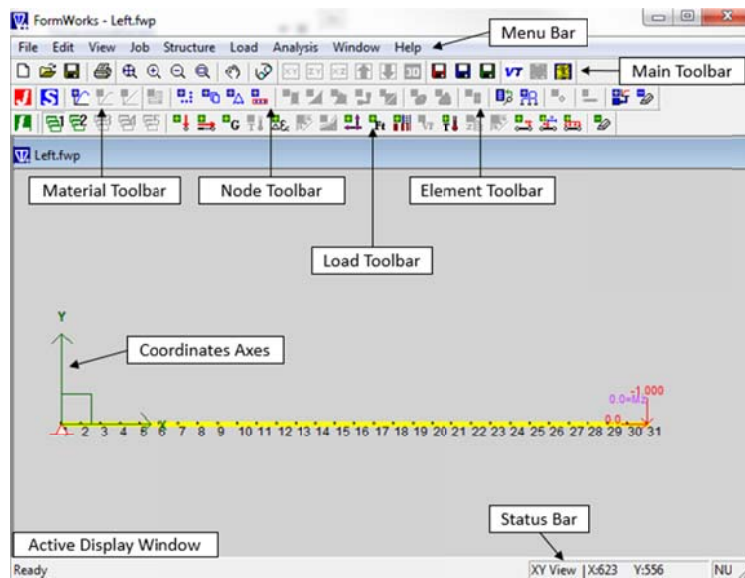

Fig. 2 FormWorks-Plus graphical environment

3. FormWorks-Plus main features

3.1 Material types

For advanced analysis of reinforced concrete structures, most of the available finite element analysis packages use a micro-modelling concept where fine details of the structure are modelled separately. The VecTor programs follow a macro-modelling concept based on smeared rotating crack approach. The macro-modelling approach avoids the complex modelling procedure and high computational demand associated with micro-modelling approach, thus better enabling the analysis of large structural systems. For example, in modelling steel-concrete (SC) composite elements, the micro-modelling approach requires modelling individual anchor studs and tie-bars as well as concrete and steel. In the macro-modelling approach, however, the composite properties of materials can be directly taken into account. Details of the formulation of the analysis model for SC composite material can be found in Vecchio and McQuade (2011). The basis of the constitutive laws for other composite material types are similar.

FormWorks-Plus provides user-friendly window dialogs to input material parameters for different types of structures. For example, to define cross sections for frame structures, the user only requires to input the general material properties of the section. The program can generate concrete layers and compute and assign transverse and out-of-plane reinforcement ratios to each layer based on the stirrup configuration automatically. The display feature of the material dialog window allows the user to see the main properties of the cross section including: cross-sectional dimensions, concrete layers configuration, stirrup type, and location and amount of each longitudinal reinforcement layer. Several drop lists are provided enabling the user to, for example, choose reinforcement bar area from a wide range of standard bar sizes included in the program or select proper member type from different available options such as nonlinear frame, nonlinear truss, compression (or tension) only member, and linear member. These features help engineers to save time and reduce the possibility of making errors, thus making the process of setting up the structural model more transparent and resulting in a feeling of confidence in the user. Fig. 3 demonstrates the Define Longitudinal Reinforcing Bar Layer Properties page which is one of the three dialog windows used in defining material properties for frame structures.

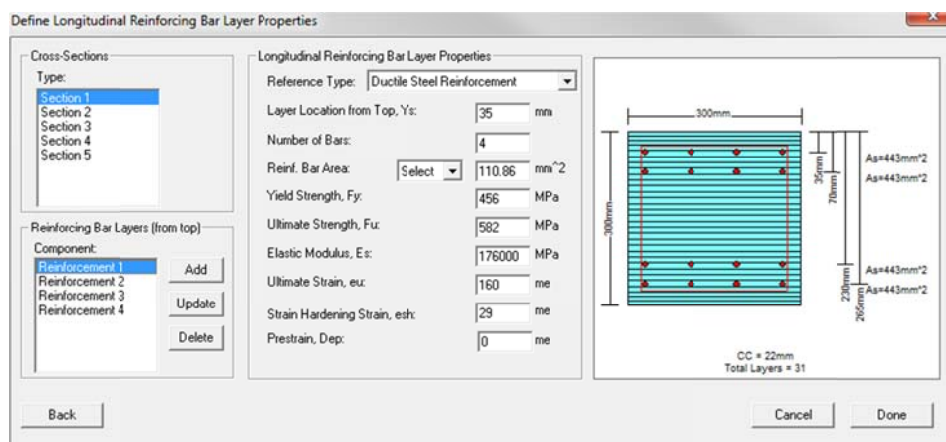

Fig. 3 Define Material Properties page for frame structures

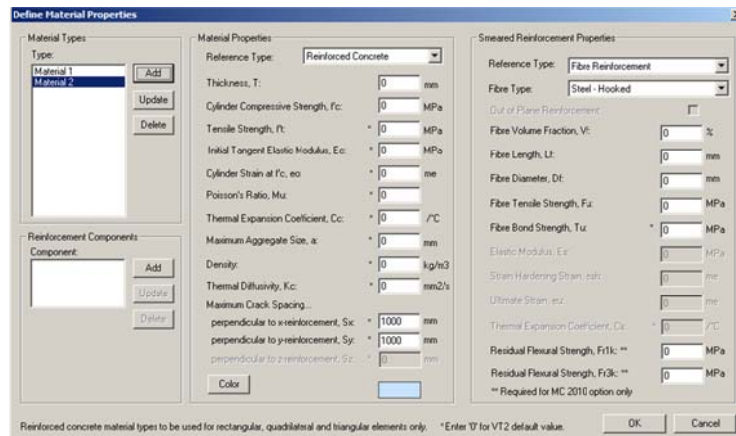

Fig. 4 Define Material Properties dialog window for 2D membrane structures

FormWorks-Plus supports a large selection of material types including: Reinforced Concrete, Structural Steel, Masonry, and Wood. Most of these material types can be modelled with or without smeared components. The components that are available to be used with the above material types are: Ductile Steel Reinforcement, Prestressing Steel, Tension (or Compression) Only Reinforcement, External Bonded FRP Fabric, Fibre Reinforcement, Steel Skin Plate, SFRC Laminate, Orthotropic Laminate, and Shape Memory Alloy Type 1 (or Type 2).

Brief descriptions of how to model the above materials and their components in FormWorks-Plus are included in the following sections. Based on the selected material type and the component type, the program only displays the related input parameters and greys out other input boxes automatically (Fig. 4).

3.1.1 Reinforced Concrete

Reinforced Concrete is the main material type in FormWorks-Plus which includes several components. The following is a short explanation of some of these components.

- Fibre Reinforcement

The two types of fibres that can be modelled in the program are steel fibres and polypropylene fibres. Steel fibres can be used to increase concrete strength and reduce the amount of required conventional steel bars. Also, they improve durability of concrete by reducing and controlling the crack width. While polypropylene fibres are not as strong as steel fibres, they have number of advantages over steel fibres. They do not expand in high temperatures or contract in low temperatures, helping to reduce cracking in concrete. In addition, polypropylene fibres are able to transmit relatively high amounts of tensile stresses across large crack widths (2.0 mm and greater) which can improve the ductility of the structure significantly.

In FormWorks-Plus, both steel and polypropylene fibres can be modelled as having a deformed or a straight shape. The deformed fibres enable a stronger bond between the fibres and the concrete compared to the straight fibres. The effect of fibres on the behaviour of concrete is dependent on fibre volume content, fibre length, fibre aspect ratio, fibre tensile strength, concrete strength, and fibre orientation. The majority of these parameters are required inputs in FormWorks-Plus.

- Steel Skin Plate

Steel-concrete composite wall elements typically consist of a thick concrete core integrated with two thin steel faceplates. Forces are generally transferred between the concrete and the steel

mainly by shear studs (Fig. 5(a)). In the VecTor programs, the DSFM is the basis for the analysis of concrete sections reinforced with steel laminates or faceplates. The analysis procedure is described fully by Vecchio and McQuade (2011).

- SFRC Laminate

Similar to the Concrete-Steel Laminate, a Concrete-SFRC Laminate combines a concrete core with steel fibre reinforced concrete (SFRC) surface layers. Using an SFRC laminate will result in a higher capacity and a more ductile response. A common application of the SFRC laminate is in strengthening of RC slabs, whereby a thin layer of SFRC is applied to an existing RC wall or slab. There are also benefits in shear capacity. An overlay of SFRC allows for increased post-cracking residual stress as the steel fibres are efficient at controlling large cracks in most circumstances (Bonaldo *et al.* 2005).

In FormWorks-Plus, in the reference type section, the user can also select Masonry instead of Reinforced Concrete to model Masonry-SFRC laminate.

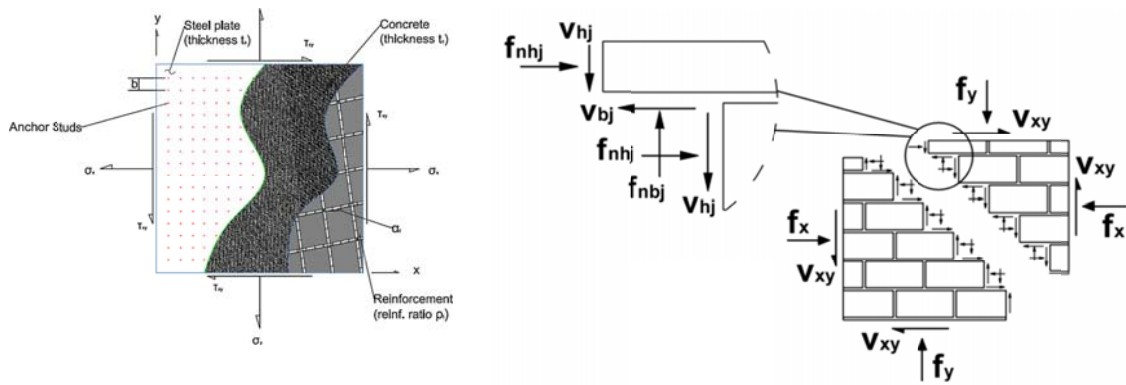

(a) Stresses in SC Laminate (Vecchio & McQuade 2011) (b) Global and local stresses in Masonry (Facconi *et al.* 2014)

Fig. 5 Stresses in SC Laminate structure and Masonry structure

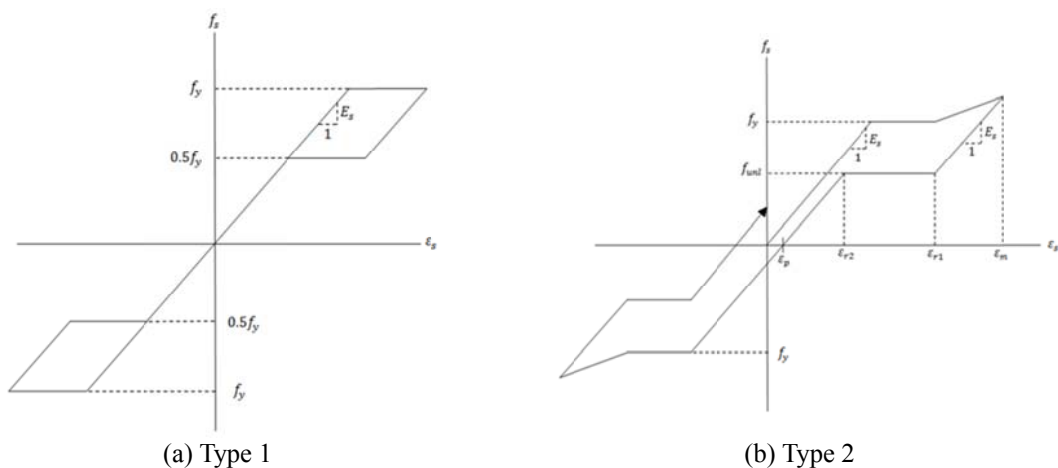

(a) Type 1 (b) Type 2

Fig. 6 The stress-strain response for Shape Memory Alloy

- Orthotropic Laminate

The Concrete-Ortho Laminate is a combination of a concrete core and wood (or other orthotropic material) faceplates. Concrete-wood laminates are commonly used in both floor and beam construction. In new floor construction, solid concrete is typically placed on timber floor beams or a solid layer of wood. The wood layer functions to replace the cracked concrete-steel reinforcement section of a solid concrete slab, and also reduces the need for formwork. Similarly, deep beams benefit from concrete-wood composite construction, as wood can help reduce or eliminate the high tensile stresses in the concrete. Hence, bridges can also utilize composite concrete-timber decks (Gutkowski *et al.* 2010). As with other laminates, forces must be transferred between the concrete and the wood, most likely through shear studs.

- Shape Memory Alloy Type 1 and Type 2

Shape Memory Alloy (SMA) materials can be used to replace conventional reinforcing steel under seismic loading conditions, and are useful due to the material's ability to dissipate large amounts of energy without excessive permanent deformation. The hysteresis for the conventional reinforcing steel includes large strain offsets; after an earthquake, the structure may be left with a large residual displacement. SMA materials minimize or eliminate these large strain offsets such that after a seismic event, the structure will retain its original shape or the deformations will be much smaller than if the conventional reinforcing steel was used.

The idealized behaviour of SMA, with no strain offsets, is modelled with SMA Type 1. Developed at the University of Ottawa, the hysteresis for SMA Type 2 differs from SMA Type 1 in that it incorporates strain hardening as well as small strain offsets (Abdulridha *et al.* 2013). Fig. 6 shows the stress-strain response of SMA Type 1 and Type 2, where f_y is the yield stress, f_{unl} is the unloading stress, ϵ_p is the strain offset, ϵ_{r1} and ϵ_{r2} are the reference strains, and ϵ_m is the maximum strain. In the FormWorks-Plus, the input parameters are same as the conventional steel reinforcement.

3.1.2 Structural Steel

Structural Steel is modelled as a linear-elastic material up to the point of yielding, after which plastic deformation and strain hardening occur. For the most part, the input parameters in FormWorks-Plus are similar to that of Ductile Steel Reinforcement.

3.1.3 Masonry

Masonry is a composite material consisting of masonry units and mortar joints. Masonry is an orthotropic material, due to the geometry and different mechanical properties of the units and joints. As with the smeared crack approach for the analysis of cracked concrete, for sufficiently large masonry structures, the masonry can be modelled as a continuum with average properties where joint failures are smeared across the single finite element (Lourenco 1996). Recently the DSFM model was extended to unreinforced masonry structures subjected to monotonic loads. The unique feature of the model is that it can analyze the local shear response of the joints by modelling their behaviour separately (Facconi *et al.* 2014). Fig. 5(b) illustrates the local stresses for masonry structures in DSFM model. To ensure equilibrium is satisfied, local shear (v_{hj} and v_{bj}) and normal stresses (f_{nhj} and f_{nbj}) are required to balance external applied stresses (f_x , f_y , and v_{xy}). In local stresses, the hj and bj subscripts stand for the head joint and bed joint, respectively.

3.1.4 Wood (fixed orthotropic)

Wood is modelled as a fixed orthotropic material in which the two directions of orthotropy are

parallel to the grain and perpendicular to the grain. The longitudinal direction is defined as parallel to the grain; the transverse direction is perpendicular to the grain. When modelling wood in FormWorks-Plus, the user must define the properties in both the longitudinal and transverse directions. For the stress-strain curve of wood material, which is used in the analysis procedure, refer to Hasebe and Usuki (1989).

Table 1 identifies the input parameters for each material type in FormWorks-Plus.

3.2 Viewing options

There are several viewing features implemented in FormWorks-Plus which enable the user to conveniently view the finite element model from different angles. The following is a brief explanation of each feature.

Table 1 Input parameters for each material type in Formworks-Plus

Material type	Input parameters
Reinforced Concrete	thickness, compressive strength, tensile strength, elastic modulus, strain at peak stress, poisson's ratio, density, max. aggregate size
Fibre Reinforcement	volume fraction, length, diameter, tensile strength, bond strength
Steel Skin Plate	thickness, poisson's ratio, yield strength, ultimate strength, elastic modulus, ultimate strain, strain hardening strain, prestrain
SFRC Laminate	thickness, volume fraction, length, diameter, tensile strength, bond strength, concrete compressive strength, concrete tensile strength, concrete elastic modulus
Orthotropic Laminate	thickness, direction, long. & trans. compressive strength, long. & trans. tensile strength, shear strength, long. & trans. elastic modulus, long. & trans. poisson's ratio
Shape Memory Alloy	direction, ratio, diameter, yield strength, ultimate strength, elastic modulus, ultimate strain, strain hardening strain, prestrain
Structural Steel	thickness, yield strength, ultimate strength, elastic modulus, ultimate strain, strain hardening strain, poisson's ratio, density
Masonry	thickness, compressive strength, tensile strength, elastic modulus, strain at peak stress, poisson's ratio, density, max. aggregate size, joint spacing
Wood	thickness, direction, long. & trans. compressive strength, long. & trans. tensile strength, shear strength, long. & trans. elastic modulus, long. & trans. poisson's ratio, density

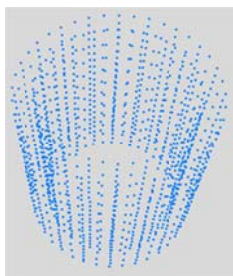

(a) Nodal view

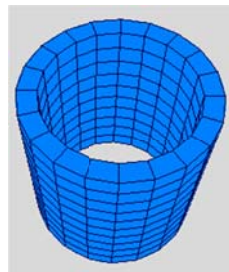

(b) Solid view

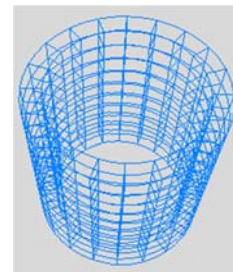

(c) Mesh view

Fig. 7 3D views in FormWorks-Plus

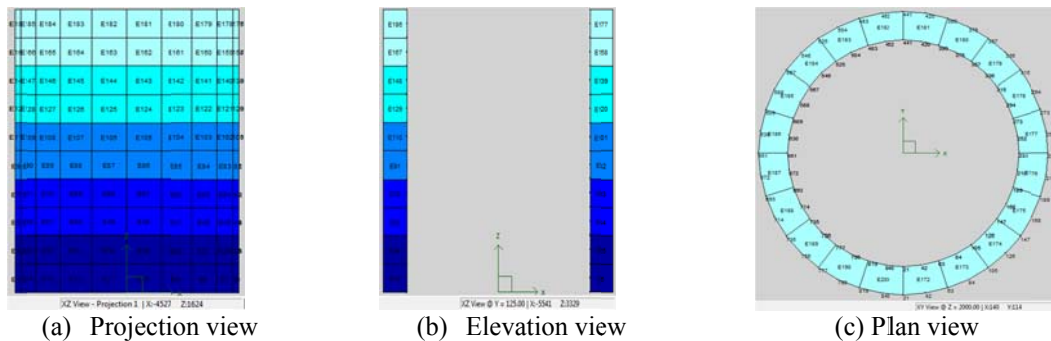

Fig. 8 Section and Projection views in FormWorks-Plus

- 3D view

FormWorks-Plus is enhanced with OpenGL (an advanced graphical tool) which enables drawing and displaying 2D and 3D structural models on the screen. The mouse buttons or the viewing icons in the main toolbar enable the user to zoom in, zoom out, move, or rotate the model in a user-friendly fashion.

- XY view, XZ view and ZY view

This facility allows the user to view the finite element model from different planes. For each plane, there are two viewing options available. The first option is a sectional view which allows making a section in a specified coordinate plane. For instance, to make a section in XY view one must specify the Z-coordinate of the section and then click on the OK button. The second option is to view the projection of the structure on different planes. This can be helpful when the user wants to view the change in material types or loads in the entire finite element model. For each viewing dialog box, there are two projection views. One displays the projection of the structure to the right (top) side and the other shows the projection to the left (bottom) side. At the bottom of the main window, the status bar shows the active plane and the location of the section.

- Quick section

With complex finite element models, finding the exact coordinates of the nodes and making a section at those points is not easy and can consume much time. This feature helps the user to automatically find the next (or previous) node and make a section at that location.

Figs. 7 and 8 show different viewing options for a cylinder structure in FormWorks-Plus.

3.3 Auto-Meshing feature

FormWorks-Plus provides two methods for defining the finite element mesh: a Manual method and an Automatic method. In the Manual method, which is available for all types of structures, the user inputs nodes and elements information manually. The increment feature of the program enables defining several nodes and elements in the X, Y, and Z directions simultaneously. The Manual method gives complete control over the mesh topology, but it can be time consuming for complex geometries and difficult for the novice users. Table 2 shows the element types supported by the VecTor and FormWorks-Plus programs.

For 2D membrane and 2D frame structures FormWorks-Plus is enhanced with a user-friendly Auto-Meshing feature. This facility enables the user to automatically create and number nodes and elements and assign restraints and material properties to the model. Moreover, for frame structures,

based on the assigned materials and their cross-sectional dimensions, FormWorks-Plus automatically creates the joint panel zone by generating nodes at the face of the beams and columns. VecTor5, which is responsible for the analysis of frames, assumes plane sections remain plane; therefore it is unable to analyze the disturbed regions such as beam-column joints where the strain distribution is significantly nonlinear (Guner 2008). Creating the joint panel zone automatically allows the user to easily select the corresponding frame elements to either strengthen them or replace them with more powerful elements. The former method avoids cracking and failure in the disturbed region while the latter method enables engineers to analyze the disturbed region. The latter method is explained in detail in the next section. Fig. 9 illustrates the Auto-Meshing dialog window for frame structures.

The current version of FormWorks-Plus does not provide Auto-Meshing feature for 3D structures including solids and shells. Having Auto-Meshing facility for all types of structures would allow easier redefinition and refinement of mesh and save much time.

Table 2 The element types supported by FormWorks-Plus for each VecTor program

Program	Structure type	Elements type
VecTor2	2D membrane	4-noded: Rectangular and quadrilateral elements
		3-noded: Triangular element
		2-noded: Truss, link, and contact elements
VecTor3	3D solid	8-noded: Regular and isoperimetric hexahedral elements
		6-noded: Wedge element
		2-noded: Truss, link, and contact elements
VecTor4	Plates and shells	9-noded: Heterosis element
VecTor5	Plane frames	2-noded: Truss element
VecTor6	Axisymmetric solids	2-noded: Frame element
		4-noded: Axisymmetric rectangular element
		3-noded: Axisymmetric triangular element
		2-noded: Truss element
		1-noded: Ring element

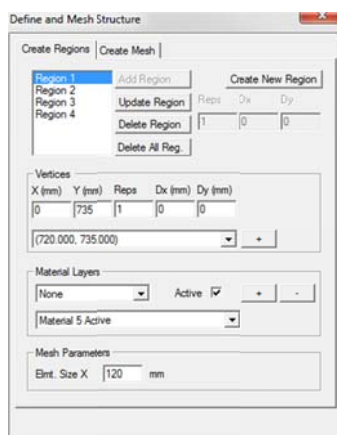

(a) Define Region page



(b) Create Mesh page

Fig. 9 Auto-Meshing window in FormWorks-Plus

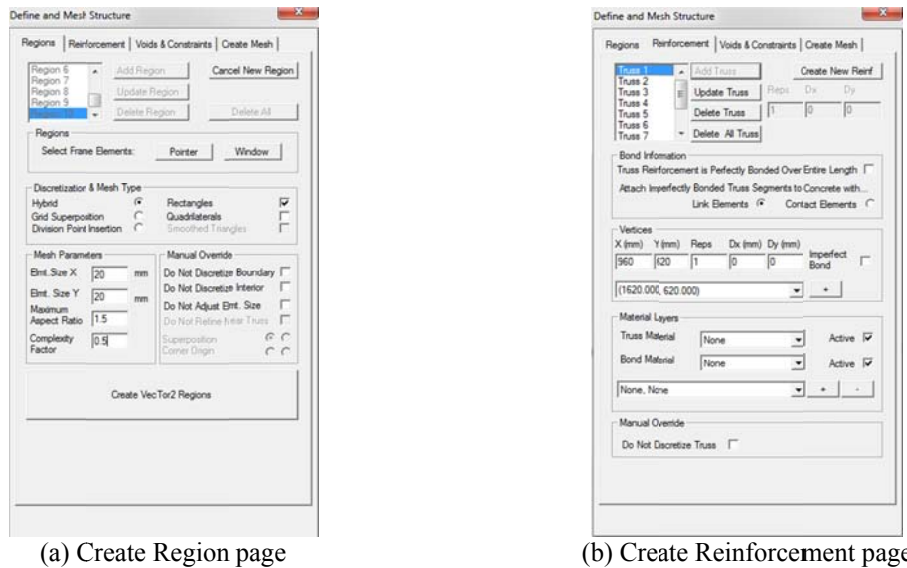

Fig. 10 Auto-Substructuring window in FormWorks-Plus

3.4 Auto-Substructuring feature

As shown in Table 2, each VecTor program is responsible for the analysis of a specific type of structure. However, there are many instances where engineers need to model and analyze the entire structure and investigate the interaction between different structural components to have a better understanding of the structure's behaviour, strength, and failure mechanism. For example, in a typical building, a moment resisting frame (2D frame) may act compositely with floor slabs (3D plate) and shear walls (2D continuum). Recently, an integrated analysis program, Cyrus, was developed enabling the user to combine structural components and analyze the interaction between substructures using the VecTor modelling facilities. In addition, the program was enhanced with the parallel processing technique which avoids the computational time and memory storage limitations associated with the stand-alone analyses. Cyrus, thus enables engineers to analyze larger and more complex structures (Sadeghian *et al.* 2015).

To conveniently model multiple substructures with different structure types, a special structure type, Mixed-Type, was implemented in FormWorks-Plus. The Mixed-Type structure type provides user-friendly dialog windows to define new substructures or delete existing substructures. It also enables the user to switch between substructures and set the workspace environment including analysis options, node and element types, material properties, and load specifications according to the selected substructure type.

In addition to allowing the user to define substructures manually, FormWorks-Plus provides Auto-Substructuring feature which facilitates the process of creating and connecting the structural components (Fig. 10). This feature allows the user to select the critical frame elements in the VecTor5 model and easily replace them with membrane elements in VecTor2, which is a more detailed finite element analysis program. Also, the Auto-Substructuring feature creates interface elements between the two finite element sub-models automatically. The interface elements solve the compatibility issues between frame elements, which have translational and rotational degrees of freedom (DOFs), and membrane elements, which only have translational DOFs. A detailed

description regarding interface elements is provided in the Cyrus User's Manual (Sadeghian and Vecchio 2014). At the conclusion of the process, FormWorks-Plus renumbers node and element numbers according to the final sub-models configuration.

3.5 Other features

Many other facilities were implemented in FormWorks-Plus to improve the functionality of the program and make the modelling process less tedious and more attractive for engineers. The following is a brief description of some of the features.

- Polar coordinate system was included, greatly facilitating the modelling process of curved structures.
- Window Selection and Pointer Selection features were implemented which make the process of selecting nodes, elements, restraints, and loads easier for the user.
- A summary page and a graph feature were provided for complex load types, giving the user a better understanding of the applied loads.
- An Insert feature was added to the program to import node coordinates, created by a drawing software like AutoCAD, from a text file. This option facilitates setting up the finite element model for complex geometries and saves much time.

For a full description of FormWorks-Plus features, refer to Sadeghian (2012).

4. Application examples

4.1 Beam-column joint

Shiohara and Kusuhara (2007) conducted a test program to investigate the response of six half-scale RC beam-column joints under quasi-statically reversed cyclic load. Specimen A2 was selected for modelling and analysis in this section. The primary objective of the study was to demonstrate the advantages of using FormWorks-Plus for creating the finite element models. In addition, the study intended to compare the analysis results against the experimental results and illustrate the improvements in the response of the substructure analysis over the stand-alone analysis.

The test setup and specimen dimensions are illustrated in Fig. 11(a). Also, the cross-sectional dimensions and reinforcement layout are illustrated in Fig. 12. The loading conditions considered in the experimental program were a constant axial force of 216 kN and a horizontal reversed cyclic load in a displacement controlled manner. The loads were applied at the top of the column.

In this paper, as described in the following, two analysis studies were conducted to compute the response of the test specimen.

Part 1) Stand-Alone Frame Analysis: A Frame model of the entire structure (joint, beams, and columns) was created in FormWorks-Plus and analyzed using the frame analysis program, VecTor5.

Part 2) Mixed-Type Analysis: With the help of the Auto-Substructuring feature of FormWorks-Plus the joint region of the frame model was replaced with a 2D membrane model in VecTor2 and a mixed-type structure analysis was performed using Cyrus.

Each part of the study is described briefly in the following. For more detailed explanation and step by step procedure of the modelling refer to Cyrus User's Manual (Sadeghian and Vecchio

2014).

4.1.1 Stand-alone frame analysis

Based on the reinforcement layout and joint region dimensions, the structure was divided into different material zones. Concrete and reinforcement properties were defined in the Material Properties window of FormWorks-Plus. Similar to most frame analysis software, VecTor5 is unable to analyze the disturbed regions; thus, to avoid cracking and failure in the joint panel, the amount of reinforcement was increased by a factor of two in this zone as suggested by Guner (2008).

Nodes and frame elements were created using the Auto-Meshing facility. FormWorks-Plus automatically detects the disturbed regions including beam-column joints and elements with nodal loads or support restraints, and strengthens them by assigning proper material types to avoid cracking and failure in these regions. The bottom end node of the column and the left end node of the beam were selected using the Window Selection option and restrained in the both X and Y directions and only the Y direction, respectively.

In the load section of FormWorks-Plus, a negative unit force was applied in the Y direction and a positive unit displacement was applied in the X direction at the top end node of the column (Figs. 13 and 14, respectively). In the analysis option section, the nodal force was chosen to be constant with a load factor of 216 kN and the displacement load was chosen to be reversed cyclic with the same pattern as the horizontal applied load in the experiment.

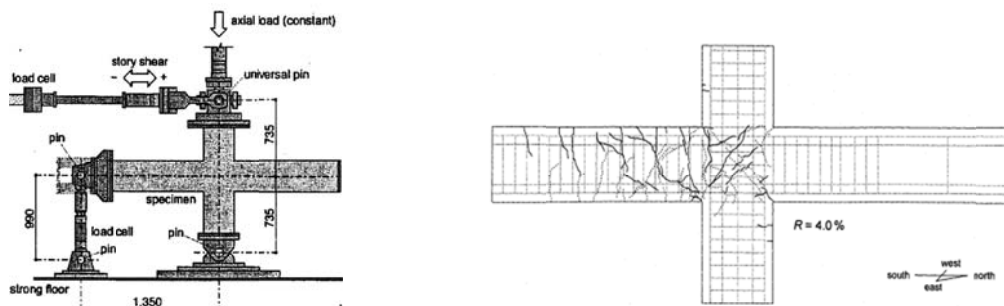

(a) Test setup

(b) Crack pattern at the ultimate load stage

Fig. 11 A2 specimen test setup and crack pattern (Shiohara and Kusuhara 2007)

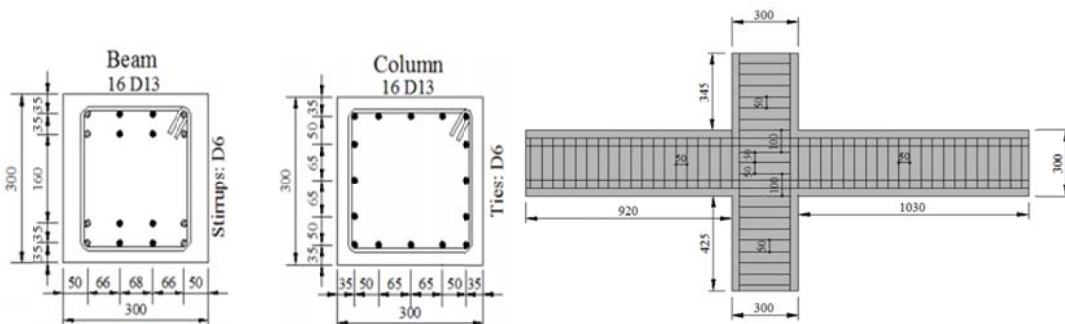

Fig. 12 Cross-sectional dimensions and reinforcement layout

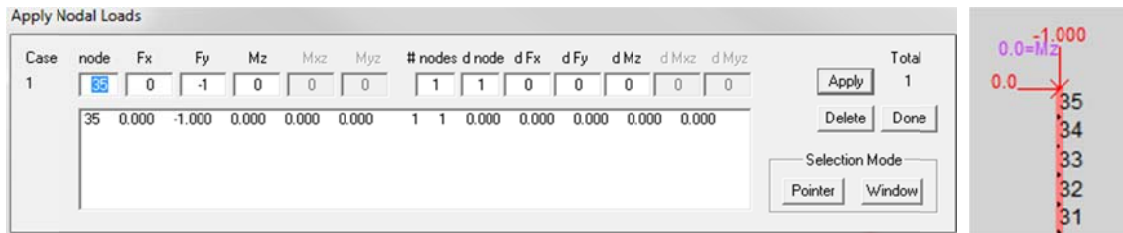

Fig. 13 Negative unit force in the Y direction at top of the column

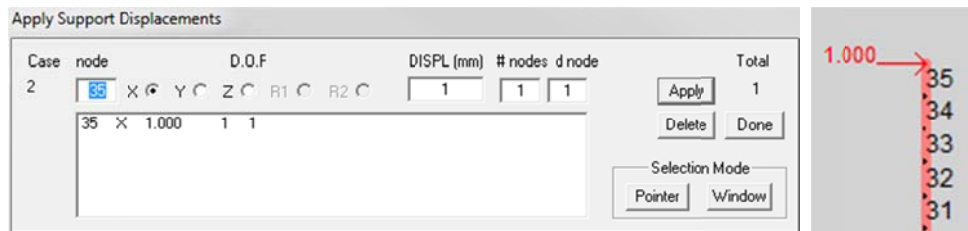

Fig. 14 Positive unit displacement in the X direction at top of the column

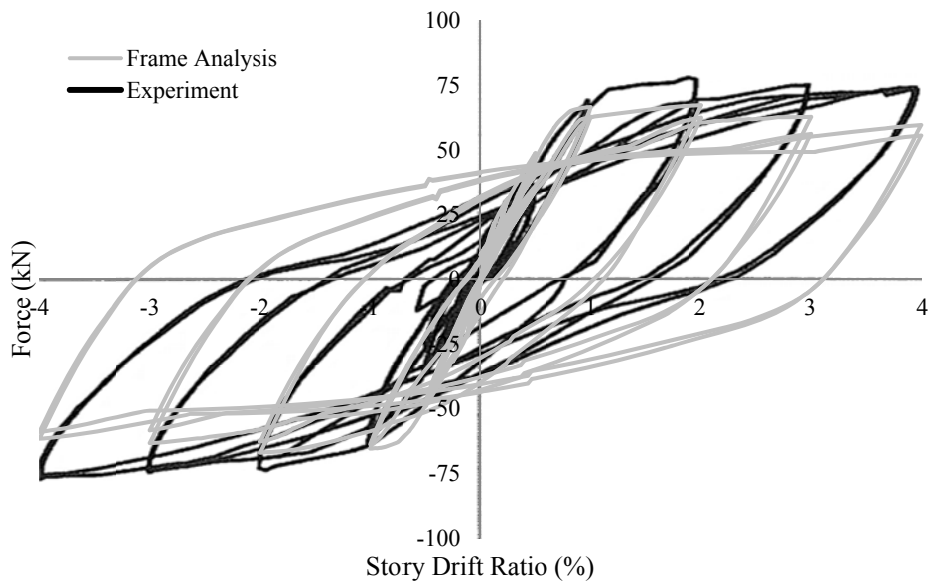

Fig. 15 Frame analysis and experimental load-deflection response for specimen A2

After setting up the finite element model and specifying proper analysis options, the user can start the frame analysis from FormWorks-Plus by clicking on the Run button. The analytical and experimental load-deflection results are presented in Fig. 15.

Based on the analysis results, VecTor5 calculated the overall response of the structure reasonably well. However, the load capacity after the first two cycles was considerably underestimated. Also, the pinching effect in the load-deflection response was not captured accurately and was underestimated. These issues are mainly due to the limitations associated with

VecTor5 program. Most frame analysis programs, including VecTor5, assume plane section remains plane and perfect bond between reinforcement and concrete in their analysis procedure. However, according to the experimental results (Fig. 11(b)), the test specimen experienced major cracks in the joint panel zone which is considered to be a disturbed region. Also, there were noticeable slips between the reinforcement and concrete at the joint region and extension of the left beam.

4.1.2 Mixed-type analysis

To overcome the limitations associated with VecTor5 program and most frame type analyses, and capture the peak loads and pinching effect more accurately, the critical part of the structure can be modelled using VecTor2 which is a more detailed analysis software. Cyrus can be used to combine the two finite element sub-models (VecTor2 and VecTor5) and analyze the entire structure.

To set up the mixed-type model, in the Auto-Substructuring window of FormWorks-Plus the frame elements which were located in the critical part of the structure were selected and replaced with a 2D membrane sub-model. The program automatically deletes the selected frame elements, replaces them with the membrane elements, and adds the interface elements. For beam-column subassemblies, usually the critical zone consists of the joint region and an extension of connecting members in each direction. The amount of extension can vary depending on how critical is the member. For this study, based on the stand-alone frame analysis results and the experimental crack pattern presented in Fig. 11(b), the left beam is heavily cracked and thus considered a critical member. Accordingly, the joint region was extended 240 mm (80% of the member height) from face of the column into the left beam. For the columns and right beam, since there were no signs of major cracking, a minimum extension (around 30% of the member height) was chosen.

For the 2D membrane sub-model, rectangular and truss elements were used to model concrete and longitudinal reinforcement, respectively. The transverse reinforcement was modelled as smeared. In addition, link elements were used between rectangular elements and truss elements to capture any possible slip between concrete and longitudinal reinforcing bars. In the next step, the concrete, reinforcement, and bond material properties were defined using FormWorks-Plus user-friendly dialog windows and assigned to the rectangular, truss, and link elements, respectively. One of the main parameters in defining bond material is the confinement pressure factor. In FormWorks-Plus, for embedded bars, a confinement pressure factor of zero corresponds to the unconfined case of splitting failure, while a confinement pressure factor of one corresponds to the confined case of pullout failure. The confinement pressure factor was computed to be 0.19 and 1.00 for the beam extensions zone and joint panel zone, respectively. For more information about bond properties and models, refer to VecTor2 User's Manual (Wong *et al.* 2013). The stand-alone frame model and mixed-type frame-membrane model are illustrated in Fig. 16.

After defining the two sub-models in FormWorks-Plus, the integrated analysis program, Cyrus, was used to combine the sub-models and perform the analysis for the entire structure based on the substructure techniques.

The experimental and mixed-type analysis load-deflection results are presented in Fig. 17. It can be seen that the mixed-type analysis predicted the peak loads and pinching effects with better accuracy than the stand-alone frame analysis. The reason is that unlike frame analysis software, VecTor2 is applicable for the joint panel zone where the strain distribution is significantly nonlinear. In addition, the VecTor2 sub-model was able to compute the slip in the critical part of the structure and consider it in the analysis.

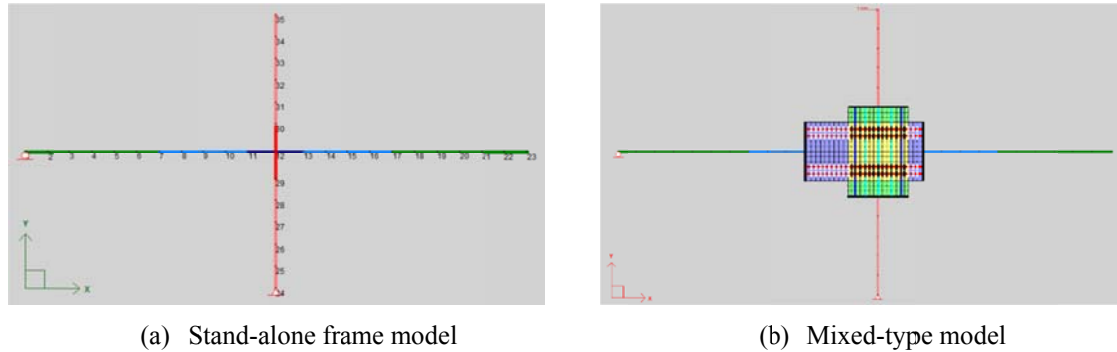

Fig. 16 Beam-column joint finite element models in FormWorks-Plus

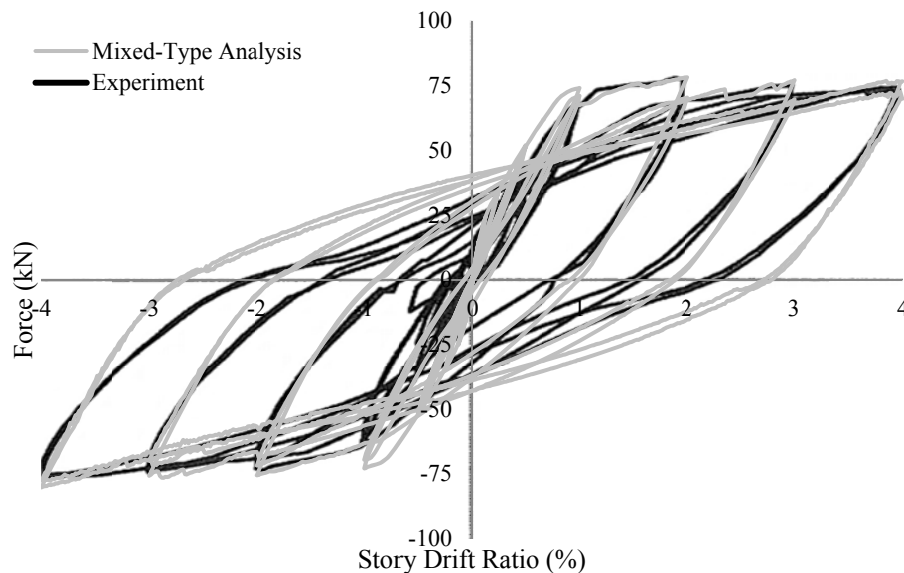

Fig. 17 Comparison of the load-deflection response of the experimental study and mixed-type analysis

4.2 Steel-concrete (SC) composite wall

Ozaki *et al.* (2001) performed shear and bending tests on a number of SC walls. Test parameters included web and flange steel plate thicknesses and shear span ratio. For all specimens, the ratio of stud spacing to plate thickness (b/t_s) was 30 and the cross section dimensions were similar. Specimen BS70T10, which was designed to reach its shear ultimate strength before yielding of the flange plates, will be modelled and analyzed here. Thick steel plates, known as “bending stiffeners”, were used at the end faces of the flanges to avoid their yielding due to bending. Also, at the intersection of the flanges and the web, steel plates were used to provide a heavily confined zone. The specimen dimensions and thickness of the steel plates are given in Fig. 18. The intention of this example is to demonstrate the application of some of the material types

available in FormWorks-Plus.

The structure was modelled in FormWorks-Plus using the Auto-Meshing feature. The web was modelled using 8-DOF rectangular elements with SC composite material type developed recently in FormWorks-Plus and VecTor2 programs. The flanges were modelled using conventional RC rectangular elements. The faceplates and bending stiffener of the flanges were modelled with truss bar elements instead of steel plates to avoid incorrectly introducing confinement to the web. To capture confinement effects due to steel plates of the web and column steel plates of the flanges, smeared out-of-plane reinforcement components with the ratios of 0.36% and 2% were added to the web and flange materials, respectively.

The material properties used in the experiment are described in Table 3. The strain hardening and ultimate strain values were not provided; thus a tri-linear response was assumed with strain hardening at 10×10^{-3} and ultimate strain at 150×10^{-3} . Also, since the material properties of the steel plates of the flanges were not provided, they were assumed to have similar properties as the web steel plates.

Nodes at the bottom row were restrained in the both X and Y directions to provide fully fixed condition at the base. Lateral force was applied as an imposed displacement load at the mid-height of the top slab. The load was monotonically increased until failure with the increments of 0.5 mm. In addition, the self-weight of the structure was considered with a constant gravity load applied on all rectangular elements. Fig. 19(a) shows the finite element model created in FormWorks-Plus. It should be noted that all the material models and analysis options were set to the default values of the VecTor2 program and no fine tuning of the analysis parameters was performed.

A brief parametric study was performed to investigate the sensitivity of the results to mesh size and load step. The calculated load-deflection responses are compared to the experimental results in Fig. 20. The mesh sensitivity analysis was performed using three different mesh sizes with 0.2 mm load increments. Details of each mesh size are described in Table 4. For the load step sensitivity analysis, four different load increments ranging from 0.2 mm to 2 mm were selected. All the analyses were performed using mesh Type 3. The parametric study demonstrated that the peak load and the decay in the post-peak response were somewhat sensitive to the mesh size. As the mesh became finer, the analysis results converged and correlated better with the experimental behaviour. The load step sensitivity test showed only minor effect on the results compared to the mesh size. Analyses with different load increments resulted in the same peak load value. However, as the load increments became larger, the analysis started to underestimate the initial stiffness of the structure. Therefore, mesh Type 3 with load increments of 0.2 mm produced reasonably converged values for the analysis results and was selected for comparison against the experiment.

Based on the results, the overall behaviour of the specimen was predicted reasonably well. In particular, the initial stiffness, yielding of the web plate, and ultimate load capacity showed excellent agreement with the experimental results. The ratio of the calculated to measured yield force of the web plate and ultimate load capacity of the wall were 0.99 and 1.04, respectively. In both the analysis and experiment, the wall exhibited a shear-critical behaviour with crushing of the web in diagonal planes across the center of the web and at the base of the flange. Also, similar to the experimental results, the analysis concluded that there was no yielding in the steel plates of the flanges. Fig. 19b illustrates the analysis crack pattern and deflected shape at the peak load stage.

Although in general the computed response agreed well with the experimentally observed behaviour, the analysis overestimated the stiffness in the load stages close to the peak load and the strength degradation in the post-peak response. These were likely consequences of several assumptions made in the process of creating the model and the analysis. It was assumed that the

steel plates and the concrete were perfectly bonded. However, the slip between the faceplates and the concrete can reduce the stiffness after the yielding and provide more ductility to the post-peak response. In addition, due to the two-dimensional nature of the analysis, the entire width of the flanges was considered fully connected to the web elements which can overestimate the lateral and vertical confinement of the web.

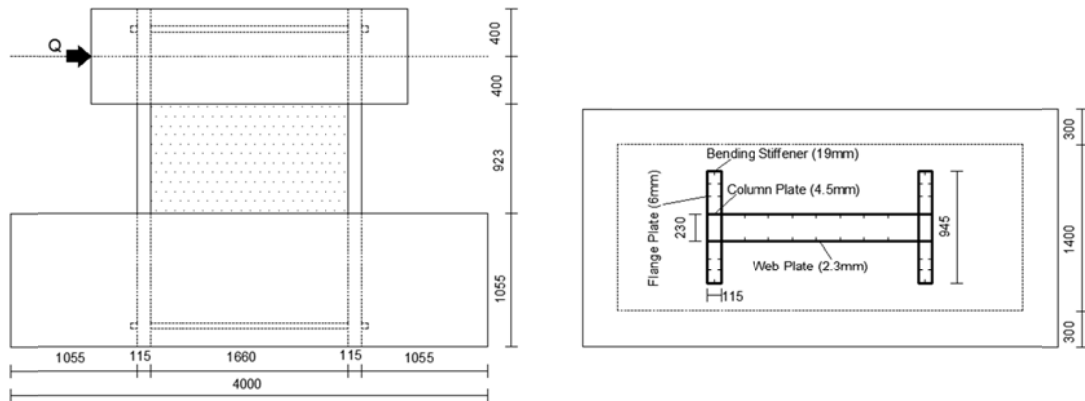

Fig. 18 Details of the BS70T10 shear wall (Ozaki *et al.* 2001)

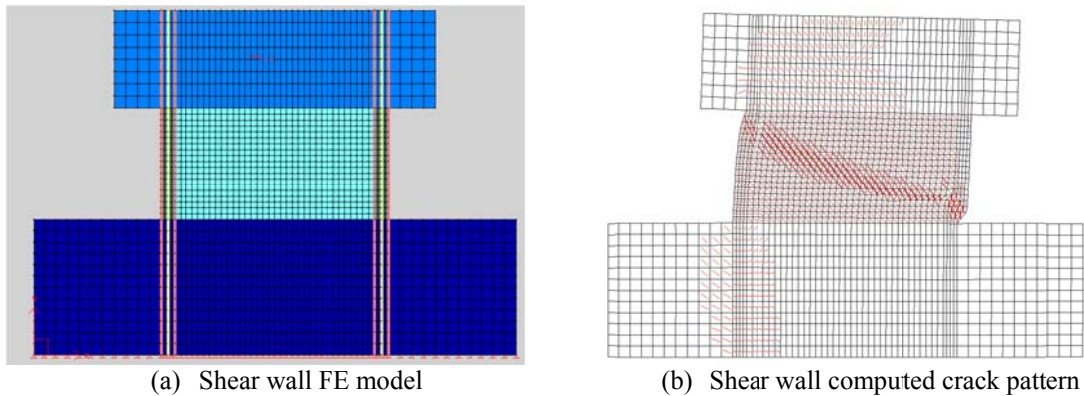

Fig. 19 FE model and computed crack pattern of the shear wall

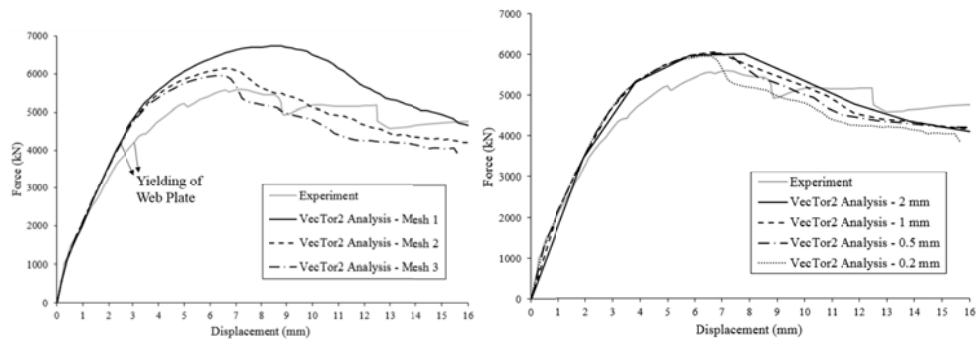

Fig. 20 Load-deflection response of the shear wall

Table 3 Material properties for BS70T10 shear wall

Material	Yield stress (MPa)	Ultimate stress (MPa)	Young's modulus (MPa)	Poisson's ratio
Web steel plate	382	503	195152	0.267
Concrete	-	33	24124	0.207

Table 4 Details of mesh size for mesh sensitivity analysis

Mesh type	Element size (mm)		Total number of elements
	Web	Flange	
1	100 × 100	60 × 100	1138
2	50 × 50	30 × 50	2200
3	40 × 40	20 × 40	2968

4.3 SFRC shear panel

Susetyo *et al.* (2013) tested a series of SFRC panels with the size of 890 × 890 × 70 mm under pure monotonic in-plane shear loads. The test parameters were fibre type, fibre-volume content, and concrete compressive strength. The test setup is illustrated in Figs. 21(a) and 21(b). To demonstrate the application of the proposed GUI for SFRC materials, Panel C1F1V2 which had 1.0% fibre-volume content from RC80/50BN fibre type, was modelled. The concrete had a compressive strength of 53 MPa and maximum aggregate size of 10 mm. The RC80/50BN type of fibre was characterized by a tensile strength of 1050 MPa, a bond strength of 3.88 MPa, a fibre length of 50 mm, and a fibre diameter of 0.62 mm. The panel also contained 40 D8 deformed wires in the longitudinal direction. The steel wires had a yield strength of 555 MPa, an ultimate strength of 647 MPa, and a modulus of elasticity of 32500 MPa.

Given the uniform stress condition within the panel, it was possible to model the specimen using a single 8-DOF rectangular element in FormWorks-Plus (Fig. 21(c)). The steel fibre component and longitudinal reinforcement were modelled as smeared. All the material models and analysis options were set to the default values of the VecTor2 program except the pre-peak compression model for which the Popovics High Strength model was selected due to the high concrete strength used in the experiment. To be consistent with the experiment, the loading was applied in a force-controlled manner. The load was monotonically increased until failure with the increments of 1 kN.

The computed load-deflection response is compared against the experimentally observed behaviour in Fig. 22. The computed response agrees reasonably well with the experimental result. The SFRC model in VecTor2 was able to consider local effects such as slip deformation due to shear stress. The local behaviour of the concrete and reinforcement correlated well with experimental results. The concrete compressive strength remained less than 20% of the cylindrical compressive strength. The longitudinal reinforcement stress remained less than 45% of the yielding strength. Therefore, in both the experiment and analysis, the failure mechanism was not governed by crushing of concrete or yielding of the reinforcement. The failure was caused by the formation of a large crack which resulted in fibre pull-out and thus loss of the fibres' ability to transmit tensile stresses across the crack. At the final load stage, the measured and calculated crack width were 0.45 mm and 0.31 mm, respectively.

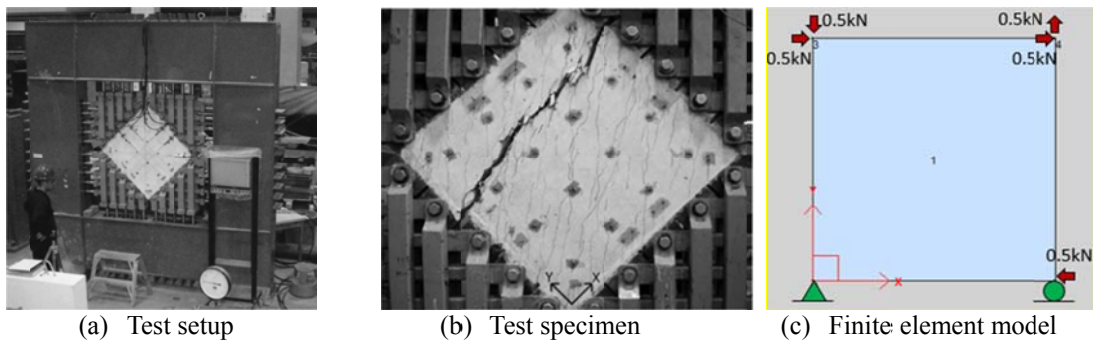

Fig. 21 C1F1V2 shear panel test setup (Susetyo *et al.* 2013) and finite element model in FormWorks-Plus

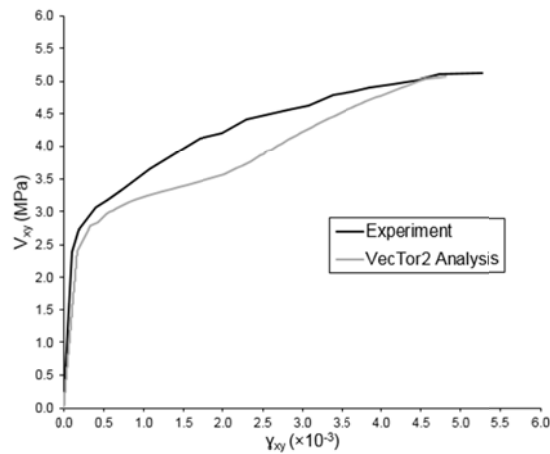

Fig. 22 Load-deflection response of the shear panel

5. Conclusions

This paper presents FormWorks-Plus, a generalized GUI which facilitates the process of creating finite element models for structural analysis programs. This newly developed preprocessor enables the user to set up finite element models for different types of structures and supports a wide range of material types. Employing several easy-to-use features in FormWorks-Plus, such as viewing options, meshing capabilities and dialog windows, help engineers create structural models in a shorter amount of time and reduce the probability of making errors. For example, the viewing toolbar allows the user to view 3D structures and take sections in different planes at any location which can greatly help in the modelling of structures with complex geometries. The facilities included in FormWorks-Plus make the modelling process more transparent for engineers, which can significantly contribute to acceptance and utilization of the analysis program.

The application of FormWorks-Plus was illustrated through modelling of a RC beam-column joint, a SC composite shear wall and a SFRC shear panel. The models developed were analyzed using VecTor finite element programs, advanced nonlinear analysis tools for RC structures. The application of FormWorks-Plus can be extended to other analysis tools by making its output text

files compatible with input values of the analysis program. The flexible and object-oriented structure of FormWorks-Plus enables easy inclusion of new output formats to the program, facilitating its usage for other analysis tools.

The development of the GUI described above is still in progress. The program is being enhanced with a 3D Auto-Meshing feature which will greatly facilitate the modelling process of complex 3D structures.

References

- Abdulridha, A., Palermo, D., Foo, S. and Vecchio, F.J. (2013), "Behavior and modeling of superelastic shape memory alloy reinforced concrete beams", *J. Eng. Mech. - ASCE*, **49**, 893-904.
- Bakewell, C.J. (1993), "How to choose a usable system for general practice", *J. Manage. Med.*, **7**(1), 12-21.
- Bonaldo, E., De Barros, J.A.O. and Lourenco, P.B. (2006), "Efficient strengthening technique for reinforced concrete slabs", *Proceedings of the International Symposium Measuring, Monitoring and Modeling Concrete Properties*, 125-131.
- Facconi, L., Plizzari, G. and Vecchio F. J. (2014), "Disturbed stress field model for unreinforced masonry", *J. Eng. Mech. - ASCE.*, **140**(4), 04013085.
- Guner, S. (2008), "Performance assessment of shear-critical reinforced concrete plane frames", Ph.D. Dissertation, University of Toronto, Toronto, Canada.
- Gutkowski, R.M., Balogh, J. and To, L.G. (2010), "Finite-element modeling of short-term field response of composite wood-concrete floors/decks", *J. Eng. Mech. - ASCE*, **136**(6), 707-714.
- Hasebe, K. and Usuki, S. (1989), "Application of orthotropic failure criterion to wood", *J. Eng. Mech. - ASCE*, **115**(4), 867-872.
- Lourenco, P.J.B. (1996), "Computational strategies for masonry structures", Ph.D. Dissertation, University of Delft, Delft, Netherlands.
- Ozaki, M., Akita, S., Niwa, N., Matsuo, I. and Usami, S. (2001), "Study on steel plate reinforced concrete bearing wall for nuclear power plants part1; shear and bending loading tests of SC walls", *Proceedings of the 16th International Conference on Structural Mechanics in Reactor Technology (SMiRT16)*, Washington DC, USA.
- Palermo, D. and Vecchio, F.J. (2002), "Behaviour of three-dimensional reinforced concrete shear walls", *ACI Struct. J.*, **99**(1), 81-89.
- Sadeghian, V. (2012), "FormWorks-Plus: improved pre-processor for VecTor analysis software", M.A.Sc. Dissertation, University of Toronto, Toronto, Canada.
- Sadeghian, V. and Vecchio, F.J. (2014), "Cyrus user's manual", University of Toronto, Toronto, Canada.
- Sadeghian, V., Vecchio, F. and Kwon, O. (2015). "An Integrated Framework for Analysis of Mixed-Type Reinforced Concrete Structures", *CompDyn 2015*, Crete, Greece.
- Schlöglmann, K.H. (2004), "Structural behaviour of masonry panels and their rehabilitation focusing on lifeline structures subjected to seismic loads", Ph.D. Dissertation, University of Graz, Graz, Austria.
- Selby, R.G., Vecchio F.J. and Collins, M.P. (1997), "The failure of an offshore platform", *Concrete. Int.*, **19**(8), 28-35.
- Shiohara, H. and Kusuhara, F. (2007), "Benchmark test for validation of mathematical models for non-linear and cyclic behaviour of RC beam-column joints", Report by Dept. of Architecture, School of Engineering, University of Tokyo.
- Susetyo, J., Gauvreau, P. and Vecchio, F.J. (2011), "Effectiveness of steel fiber as minimum shear reinforcement", *ACI Struct. J.*, **108**(4), 488-496.
- Vecchio, F.J. (2000), "Disturbed stress field model for reinforced concrete: formulation", *J. Struct. Eng. - ASCE*, **126**(9), 1070-1077.
- Vecchio, F.J. and Collins, M.P. (1986), "The modified compression-field theory for reinforced concrete elements subjected to shear", *ACI Struct. J.*, **83**(2), 219-231.

- Vecchio, F.J. and McQuade, I. (2011), "Towards improved modeling of steel-concrete composite wall elements", *Nucl. Eng. Des.*, **241**(8), 2629-2642.
- Vecchio, F.J. and Shim, W. (2004), "Experimental and analytical reexamination of classic concrete beam tests", *J. Struct. Eng. - ASCE*, **130**(3), 460-469.
- Wong, P., Vecchio, F. J. and Trommels, H. (2013), "VecTor2 and FormWorks manual", 2nd edition, University of Toronto, Toronto, Canada.

SF