



Natural Resources  
Canada

Ressources naturelles  
Canada

**GEOLOGICAL SURVEY OF CANADA  
OPEN FILE 8919**

**Project summary of samples collected in support of the  
Climate Controls on Long-term Hydrological Change in  
the Mackenzie River Basin project, Yukon and Northwest  
Territories, Environmental Geoscience Program  
and ArcticNet Project 51**

**A.V. Nguyen, A. Oleksandrenko, S. Lord, L. Clarke, M. Galka,  
R.T. Patterson, W. Shotyk, G. Swindles, and J.M. Galloway**

**2022**

**Canada**



ISSN 2816-7155  
ISBN 978-0-660-45732-1  
Catalogue No. M183-2/8919E-PDF

## GEOLOGICAL SURVEY OF CANADA OPEN FILE 8919

# Project summary of samples collected in support of the Climate Controls on Long-term Hydrological Change in the Mackenzie River Basin project, Yukon and Northwest Territories, Environmental Geoscience Program and ArcticNet Project 51

A.V. Nguyen<sup>1</sup>, A. Oleksandrenko<sup>2</sup>, S. Lord<sup>3</sup>, L. Clarke<sup>4</sup>, M. Gałka<sup>5</sup>,  
R.T. Patterson<sup>1</sup>, W. Shotyk<sup>2</sup>, G. Swindles<sup>6</sup>, and J.M. Galloway<sup>7</sup>

<sup>1</sup>Ottawa-Carleton Geoscience Centre and Department of Earth Sciences, Carleton University, 1125 Colonel By Drive, Ottawa, Ontario

<sup>2</sup>Department of Renewable Resources, University of Alberta, 116 Street and 85 Avenue, Edmonton, Alberta

<sup>3</sup>Gwich'in Renewable Resources Board, 105 Veteran's Way, Inuvik, Northwest Territories,

<sup>4</sup>Department of Natural Sciences, Manchester Metropolitan University, All Saints Building, Manchester, United Kingdom

<sup>5</sup>Department of Biogeography, Paleoecology and Nature Conservation, ul. Prez. Gabriela Narutowicza 68, 90-136, University of Łódź, Łódź, Poland

<sup>6</sup>School of Natural and Built Environment, Queen's University Belfast, Stranmillis Road, Belfast, Northern Ireland

<sup>7</sup>Geological Survey of Canada, 3303-33rd Street N.W., Calgary, Alberta

## 2022

© His Majesty the King in Right of Canada, as represented by the Minister of Natural Resources, 2022

Information contained in this publication or product may be reproduced, in part or in whole, and by any means, for personal or public non-commercial purposes, without charge or further permission, unless otherwise specified.

You are asked to:

- exercise due diligence in ensuring the accuracy of the materials reproduced;
- indicate the complete title of the materials reproduced, and the name of the author organization; and
- indicate that the reproduction is a copy of an official work that is published by Natural Resources Canada (NRCan) and that the reproduction has not been produced in affiliation with, or with the endorsement of, NRCan.

Commercial reproduction and distribution is prohibited except with written permission from NRCan. For more information, contact NRCan at [copyright-droitdauteur@nrcan-rncan.gc.ca](mailto:copyright-droitdauteur@nrcan-rncan.gc.ca).

Permanent link: <https://doi.org/10.4095/330928>

This publication is available for free download through GEOSCAN (<https://geoscan.nrcan.gc.ca/>).

### Recommended citation

Nguyen, A.V., Oleksandrenko, A., Lord, S., Clarke, L., Gałka, M., Patterson, R.T., Shotyk, W., Swindles, G., and Galloway, J.M., 2022. Project summary of samples collected in support of the Climate Controls on Long-term Hydrological Change in the Mackenzie River Basin project, Yukon and Northwest Territories, Environmental Geoscience Program and ArcticNet Project 51; Geological Survey of Canada, Open File 8919, 85 p. <https://doi.org/10.4095/330928>

Publications in this series have not been edited; they are released as submitted by the author.

## TABLE OF CONTENTS

<b>FORWARD (Plain Language; English)</b> .....	<b>2</b>
<b>Gwichih Gwidinithit'oo</b> .....	<b>2</b>
<b>PROJECT SUMMARY (Plain Language; English)</b> .....	<b>3</b>
<b>Gwitr'it Tr'iltsaii Geenjii Diiyah Tr'igwaandak</b> .....	<b>4</b>
<b>ACKNOWLEDGMENTS</b> .....	<b>4</b>
<b>INTRODUCTION</b> .....	<b>6</b>
Background .....	6
Objectives .....	7
The Mackenzie River Basin .....	7
<b>METHODS</b> .....	<b>11</b>
Site Selection .....	11
<i>Peatland Site Selection</i> .....	11
Peat Core Collection and Sub-sampling .....	11
<i>16PS1 &amp; 16PS2 Peat Monoliths</i> .....	11
<i>18-GTA-79 &amp; 18-GTA-292 Peat Monoliths</i> .....	14
<i>MAC Site Peats</i> .....	18
Depth to Water Table Measurements.....	35
Plant Macrofossils and Radiometric Dating .....	37
Palynology .....	37
Testate Amoebae Analysis.....	38
Mercury (Hg) Analysis & Inductively Coupled Plasma Mass Spectrometry (ICP-MS) .....	38
Carbon Isotope Analysis .....	39
HAWK Pyrolysis .....	40
<b>RESULTS</b> .....	<b>40</b>
Measurements for pH, TDS, and EC .....	41
Plant Macrofossils & Radiocarbon Dating .....	41
HAWK Pyrolysis .....	48
<b>DISCUSSION</b> .....	<b>51</b>
Radiometric Dates.....	51
HAWK Pyrolysis .....	51
<b>CONCLUSIONS (Plain language; English)</b> .....	<b>54</b>
<b>GUK'IIGHÈ' JÙU DIGWIINIINDHANH</b> .....	<b>54</b>
<b>REFERENCES</b> .....	<b>55</b>
<b>APPENDICES</b> .....	<b>63</b>

## FORWARD (Plain Language; English)

People living in the Mackenzie River Basin have observed decreased water levels, warmer and drier winters, thinning ice, thawing permafrost, and other changes to ecosystems in recent years. To better understand how and why water levels in the Mackenzie River Basin have changed, are changing, and will change in the future, we studied peat bogs in and near the Gwich'in Settlement Area.

Bogs accumulate and preserve the remains of plants that were growing in and around them. Some peat bogs can be many of thousands of years old. By studying the remains of tiny fossils of single-celled organisms (“testate amoebae”) preserved in deep layers of moss that accumulate in bogs and swamps, and the type of vegetation contained in them, it is possible to reconstruct how climate, plants, fires, and water levels have changed in the past. By studying metals in the peats, we can also learn about how climate can affect the movement of contaminants. Knowing more about how climate change affected water levels in the past allows us to make better predictions about how current and future climate change will affect water levels in the future in the Mackenzie River Basin and to better understand how climate change will affect the mobility of contaminants, water quality, vegetation, and fire in northern Canada.

To conduct our study, we collected vertical sections of peat (“peat cores”) from 8 peatlands in and around the Gwich'in Settlement Area. Two of the peat cores were collected from outside of the Mackenzie River Basin but near the same latitude. The peat cores were transported to the University of Alberta and Carleton University where they were sliced at 5 mm or 1 cm intervals throughout their depth. We also collected moss and vegetation samples from each of the sampled peatlands to analyze their metal content. This report catalogues the sites and samples collected, the method by which they were collected, the results of dating the peat cores, and some other results of the study so far.

## Gwichih Gwidinithit'oo

Nagwichoonjik gwa'an gwich'in kat jùu dinginuh, jùk gweendoo chuu zhàk diinch'uu, khaii guuzhik gwiyeendoo gwiniidhah ts'at googai, luu didril, nan t'eh gwithatan nagwaaghahi ts'at nan ejùk t'igwinjih. Nagwichoonjik gwa'an jaghadee chuu ejùk t'injii ts'at yeendoo ejùk t'igwiheenjaa gahgwiheedandaii geenjit Gwich'in Nànhkak gwa'an nan trah kak nìn' goonlii gwizhìt gwinyaa'in'.

Nan trah zhìt ts'at geeghee gwinzhìh nahshii aii nan trah zhìt diinch'uh. Nan trah gwilàt duulèh nagwidadhat thousands ezhik gwiinli'. Nan trah kak nìn' goonlii zhìt ejiich'ii nihlìnehch'i' nahshii geenjit gik'itr'aanjii k'iighè' nits'oo diinagoo'ee, gwinzhìh, kwàn' ts'at chuu dahleii gwiinli' yi'eenoo gwats'at ejùk t'igwinjii gik'itr'aanjih. Nìn' zhìt iitsii tsal goonlii geenjit gik'itr'aanjii k'iighè' nits'oo ejiich'ii iizuu diinagoo'ee zhìt t'igwinjii gik'itr'aanjih. Yi'eenoo diinagoo'ee ejùk t'igwinjii k'iighè' chuu dagwahleii gwiinli' geenjit gik'itr'aanjii k'iighè' Nagwichoonjik gwa'an yeendoo chuu dagwiheech'aa gik'itr'aanjih aii geeghee ts'at northern Canada gwinagoo'ee gwa'an nits'oo ejiich'ii iizuu t'igwinjik k'iighè' chuu, gwinzhìh ts'at kwàn' geenjit dagwiheech'aa gik'itr'aanjih.

Gik'itr'ahaandal geenjit Gwich'in Nànhkak gwa'àn nan trah nihk'ii daan nihlinehch'i' goo'arii gwats'at nìn' chyah uudhiidinjik. Nagwichoonyik eh'òk gwats'at nìn' neekaii uudhiidinjik. Nìn' uudhiidinjik University of Alberta ts'at Carleton University gwits'at nitr'iniinlii ts'at ezhik danh 5 mm gòo 1 cm diditii tr'iintù'. Aii geeghe ts'at nijin gwinyaa'in' gwats'at nìn' ts'at gwinzhih uudhiidinjik, duuleh iitsii tsal vizhìt goonlii geenjit gwinyaa'in'. Nijin gwats'at nìn' gòo gwinzhih uudhiidinjik, nits'òo uudhiidinjik, dagwahthee ezhik t'iinch'u' ts'at ezhii geenjit gik'itr'aanjik jii gwizhìt geenjit gwidinithit'oh.

## PROJECT SUMMARY (Plain Language; English)

The Mackenzie River Basin is experiencing warming surface temperatures. Warmer temperatures may be affecting water levels and flows, causing warmer/drier winters, thinning ice, thawing permafrost, and changes to the surrounding ecosystems. A combined western science and Traditional Knowledge approach is being used in the study “Long-term hydrological dynamics of the Mackenzie River Basin” to create new knowledge on how and why water levels have changed in the Mackenzie River Basin. Our study focuses on the Gwich'in Settlement Area. By better understanding how past climate change has affected water levels in the basin, we will be able to make better predictions how current and future climate change may alter water levels.

This Open File reports on the western science aspect of the study of vertical sections of peat (“peat cores”) collected from peatbogs in and around the Gwich'in Settlement Area. The Traditional Knowledge component of the study is being led by Sharon Snowshoe (Gwich'in Tribal Council, Gwich'in Department of Cultural Heritage) and Trevor Lantz (University of Victoria) and is not included in this report.

Peatlands are ideal for the study of past climate change. Peat moss and other vegetation accumulates over time in them. Eight peat cores were collected from in and around the Gwich'in Settlement Area. Some of the peat cores were collected with a peat corer designed and made at the University of Alberta and some were collected with a saw to dig out a square block of peat. The peat cores range in depth from 93 cm to 22 cm. The peat cores were sliced at 5 mm or 1 cm intervals throughout their depth, and then sampled for various analyses, including 1) study of tiny fossils (micropaleontology; testate amoebae), pollen, remains of plants, and charcoal to reconstruct changes in vegetation, fire, and water levels over time; 2) geochemistry (stable isotopes) to reconstruct changes in moisture; 3) age dating to know how old the peat cores are; 4) metal concentrations; and, 5) HAWK pyrolysis to know more about the organic matter in the peat cores.

A catalogue of the cores, the samples, and the results of the age dating and organic matter analysis are included in this report. Of the peatlands sampled in the Gwich'in Settlement Area, one has a pH of <4 (ombrotrophic bog). The peat cores range in age from 214 years old to 4993 years old. The results of the organic matter analysis show that most of the peat bogs have become wetter in the more recent years.

## Gwitr'it Tr'iltssaii Geenjit Diiyah Tr'igwaandak

Nagwichoonyik gwa'an juk gweendoo gwiiyeendoo gwiniidhah. Gwiiyeendoo gwiniidhaa k'iighè' chuu ejuk diinch'uu, khaii guuzhik gwiiyeendo gwiniidhaa ts'at guugaii, luu didril, nan t'eh gwithatan nagwaaghahi ts'at nan ejuk t'igwinjih. Jii gwitr'it geenjit gaoniltyin kat ts'at yi'eenoo Dinjii Zhuh nits'òo gugwiindai' gwinjik nihkhah Nagwichoonyik gwa'an chuu dagwahleii yi'eenoo gwiinli' geenjit gik'igaanjii k'iighè' Nagwichoonyik gwinagoo'ee gwa'an chuu jaghadèh ejuk diinch'uu gik'itr'aaanjih. Gwich'in nànhkak dagoonch'uu geenjit iisrits'at gik'itr'aaanjih. Nagwichoonyik gwa'an yi'eenoo dai' dagwiinch'u' geenjit gahgwidandaii k'iighè' juk ts'at yeendoo chuu dagwiheech'aa gik'itraanjih.

Gwich'in Nànhkak gwats'at nìn' tr'oonjik, geenjit gaoniltin kat geenjit jidii gik'igaanjik jii gwidinithit'oo gwizhìt goo'aih. Sharon Snowshoe (Gwich'in Tribal Council, Gwich'in Department of Cultural Heritage) ts'at Trevor Lantz (University of Victoria) Dinjii Zhuh k'yuu tr'igwindaii gwinjik gik'itr'aaanjii geenjit chit giinlii ts'at guugwitr'it jii gwidinithit'oo gwizhìt goo'aih kwàh.

Nan trah kak nìn' nahshii geenjit gik'itr'aaanjii k'iighè' yi'eenoo diinagoo'ee nits'òo ejuk t'igwinjih gik'itr'aaanjih. Nan trah kak nìn' ts'at gwinzhìh nihlinehch'i' gweedhaa guuzhik ezhik gwa'an nahshih. Nànhkak gwa'an nan trah nihk'ii daan nihlinehch'i' goo'aih gwats'at nìn' chyah tr'oonjik. Nan zhìt vàh khatr'igyit University of Alberta danh tr'iltssaii ts'at nan tr'it'ii gwi'iitsii hàh chan nìn' tr'oonjik. Jii nìn' 93 cm gòo 22 cm diditih. Nìn' 5 mm gòo 1 cm diditii tr'iint'u' t'èe nihlinehch'i' geenjit vizhìt kagugwinah'in', jii geenjit kagugwinah'in', 1) gwinzhìh nihlinehch'i' ts'at chii juuk'an' k'it vizhìt diinich'uu geenjit gik'itr'aaanjii k'iighè' yeeno nits'òo gwinzhìh nahshii, kwàn' gwiinli' ts'at chuu dagwiinch'ù' geenjit gik'igaanjih; 2) vizhìt ejiich'ii tsal nihlinehch'i' goonlii geenjit gik'itr'aaanjii k'iighè' yeeno nan zhìt chuu dagwiinch'u' natr'igwiiltssaii; dahthee aii nìn' ezhik goo'aih geenjit gwizhìt tr'igwinah'in'; iitsii dagwahleii gwizhìt t'iinch'uu geenjit tr'igwinah'in' ts'at, thah k'iighè' nan dagoonch'uu gwizhìt gugwinah'in' k'iighè' aii nìn' zhìt nihlinehch'i' jidii diinch'uu gik'itr'aaanjih.

Nìn' nihlinehch'i' tr'oonjik ts'at dagwahthee ezhik t'iinch'u' geenjit gik'itr'aaanjik jii gwizhìt gwidinithit'oh. Gwich'in Nànhkak gwa'an gwats'at nìn' tr'oonjik ts'at vizhìt tr'igwinah'in' k'iighè' vichù' pH < 4 nilii gik'itr'aaanjik. Aii nìn' nagwidadhat 214 ts'at 4993 ezhik t'iinch'ù'. Vizhìt nihlinehch'i' goo'aih tr'igwinah'in' k'iighè' juk gweendoo aii nan gwiiyeendoo gwiltraa gik'itr'aaanjik.

## ACKNOWLEDGMENTS

The Gwich'in Renewable Resources Board led and conducted this field work in 2020 (Sarah Lord). Steve Anderson, Jason McLeod, Julianne Chipesia, Justin Frost, Charlie Snowshoe Jr. are acknowledged and thanked for their participation in the field. Great Slave Helicopters, Inuvik, is thanked. ArcticNet funded air support for this field program through a logistics grant to Galloway. Funding for this project comes from ArcticNet Project #51 (PI Galloway), Environmental Geoscience Program, Mackenzie River Basin Project (project lead Galloway),

Gwich'in Renewable Resources Board (Lord), Natural Sciences and Engineering Research Council of Canada (NSERC) Discovery Grant for the Project entitled "Peat Bog Archives of Atmospheric Trace Elements" (PEAATE; PI Shotyk), a Research Affiliate Program Bursary (GSC; Nguyen), Ontario Graduate Scholarship (Nguyen), NSERC Postgraduate Scholarship – Doctoral program (Nguyen), University of Alberta, and Carleton University. Monoliths 18-GTA-79 and 18-GTA-292 were collected under the Geo-Mapping for Energy and Minerals Program (GSC), Western Arctic Project, Smoking Hills Activity under Aurora Research Institute Scientific Research License (ARI) #16201 (to Smith) by Galloway with assistance from Dr. Steve Grasby, Dr. Rod Smith, Dr. David Evans, Dr. Manuel Bringué, and Rebecca Bryant. Monoliths 16PS1 and 16PS2 were collected by Colleen Fish and Caroline Duchesne under ARI License #16637. Cores MAC S1 through S4 were collected by Sarah Lord (GRRB) and her team using a custom designed and built coring device by Tommy Noernberg of the University of Alberta. Samples submitted for radiometric dating to 14CHRONO lab, Queen's University, Belfast, was possible due to the NERC Arctic Office administered and UK Department for Business, Energy and Industrial Strategy (BEIS) funded UK-Canada Arctic Bursary project "Long-term hydrological dynamics of the Mackenzie River Basin" (awarded to Clarke). The translation to Gwich'in was provided by Eleanor Mitchel-Firth and verified by Gwich'in elder Joanne Snowshoe. This project is being conducted under ARI License # 16737 (to Galloway). We thank Dustin Whalen, GSC-Atlantic, for an internal peer review of this document. Metadata and data for this project can be found on the Polar Data Catalogue CCIN 13261 "Long-term hydrological change of the Gwich'in Settlement Area, Mackenzie River Basin. ArcticNet P51". Project contact is Dr. Jennifer Galloway, Geological Survey of Canada, Calgary, Alberta at [Jennifer.Galloway@nrcan-rncan.gc.ca](mailto:Jennifer.Galloway@nrcan-rncan.gc.ca)

## INTRODUCTION

### Background

Peatlands are wetlands, such as bogs and swamps, that are permanently waterlogged and are characterized by periodic standing water (Environment Canada and Wilcox, 2002; Joosten, 2015). Peatlands are distinguished from other types of wetlands by the accumulation of peat and peat-forming plants such as *Sphagnum* moss, *Eriophorum vaginatum*, and *Carex* spp. (Larsen, 1982), and predominantly occur in the boreal and sub-arctic regions (Tarnocai, 2006, 2013). While peatlands only account for approximately 3% of the Earth's surface (Yu et al., 2010), they store 21% of the total soil organic carbon stock, more carbon than the global forest biomass (Batjes, 1996; Joosten, 2015; Leifeld and Menichetti, 2018). Peatlands are therefore significant carbon sinks and are key players in the global carbon cycle. However, human activities, such as mining and drainage, have affected approximately 10% of global peatlands. Climate modeling suggests that peatlands are highly sensitive to climate change, with accelerated increases in temperature predicted to cause severe degradation and drying (Tarnocai, 2006, 2013). This degradation may release the carbon stored in peatlands as carbon dioxide and potentially contribute to further accelerated warming.

The Mackenzie River Basin (MRB) is one of the largest wetland regions in the world (Beilman et al., 2008), covering approximately 1.8 million km<sup>2</sup> over Alberta, Saskatchewan, British Columbia, the Northwest Territories, and the Yukon. The MRB is involved in sea ice formation, global thermohaline ocean circulation, carbon storage, and biogeochemical cycling. The MRB is North America's largest freshwater input into the Arctic Ocean (Vörösmarty et al., 2008) and is subject to Arctic amplification (Manabe and Stouffer, 1980), a phenomenon where surface temperatures in northern basins have been increasing 2-3 times faster in comparison to the global average since the beginning of the 20<sup>th</sup> century (Winton, 2006; Serreze and Barry, 2011; Stocker et al., 2013; Vaughan et al., 2013). Arctic amplification has already been contributing to the greening of coastal tundra (Bhatt et al., 2010), changing wind patterns (Overland and Wang, 2010), reduced terrestrial ice sheets and permafrost (Miller et al., 2010), accelerated sea level rise, and is expected to increase and expand beyond the Arctic (Lawrence et al., 2008). In the MRB, the increase in maximum surface temperatures, in addition to natural resource development, has contributed to changes in the streamflow and tributaries of the basin, and impacted permafrost and wetland distribution, lake coverage, and regional water quantity and quality (Yang et al., 2015 and references therein). People living in the MRB report decreased water levels and flows, warmer and drier winters, higher precipitation and evapotranspiration in the summer, thinning ice, and changes to the wetland ecosystems.

Ideal peatlands for paleoclimate studies are ombrotrophic bogs, whose only source of water is derived from precipitation. Ombrotrophic bogs are ideal for geochemical and paleontological analyses as they preserve atmospherically deposited metals as well as fossils that can be used for paleohydrological reconstruction. Testate amoebae have been extensively used as a proxy for reconstructing the hydrology of peatlands through the development of transfer function models. Developing transfer function training sets requires selection of at least 5-7 sites, with a minimum of 10-20 samples collected per site. The data generated from the MRB will be added to an existing pan-Arctic transfer function (Amesbury et al., 2018), which may then be used to



generate a transfer function specific to the MRB to quantitatively reconstruct changes in water-table depth through time.

## Objectives

This project represents the first time an integrated western science-Traditional Knowledge reconstruction of past climate and water level change will be produced for the MRB. Our goal is to generate long-term data and knowledge on the hydrological dynamics of the MRB to assess impacts in the Gwich'in Settlement Area (GSA). Understanding past climate dynamics and ecosystem evolution is imperative for modelling future changes in climate and its effects on sustainable natural resource development and the health of northern environments and communities. Our findings will produce a multidisciplinary framework (e.g., geochemical, micropaleontological, and Traditional Knowledge) that will provide further insight into the drivers of long-term hydrological changes in the MRB and form the basis for improved predictions using ecohydrological modelling. This Open File reports on the western science objectives and emerging results of study of peat monoliths, peat cores, surface moss samples, surface vegetation samples, and metadata collected in support of this project. The Traditional Knowledge component of the study is being led by Sharon Snowshoe (Gwich'in Tribal Council, Gwich'in Department of Cultural Heritage) and Trevor Lantz (University of Victoria) and not herein reported.

## The Mackenzie River Basin

The MRB extends across four major physiogeographic regions (Fig. 1): the Western Cordillera, the Interior Plain, the Precambrian Shield, and the Arctic Coastal Plain (Woo and Thorne, 2003). These physiogeographic zones are characterized by various climatic regimes, including cold temperate, mountain, sub-arctic, and Arctic, with approximately 75% of the basin lying within permafrost zones (Abdul Aziz and Burn, 2006; Yip et al., 2012). The MRB is dominated by tundra or sub-arctic climates. In the northern regions of the basin, ice covers the water from late September to late June; in the southern regions, ice cover occurs between mid-November to late April (Rosenberg and Barton, 1986). Nearly the entire basin comprises natural and/or semi-natural area (Statistics Canada, EETSD, 2016). This study focuses on the GSA (Fig. 2).

Eleven peat cores/monoliths were collected in total, but only eight are studied for this project: 16PS1, 16PS2, 18-GTA-79, 18-GTA-292, MAC S1-4 (Figs. 1 – 2; Table 1).

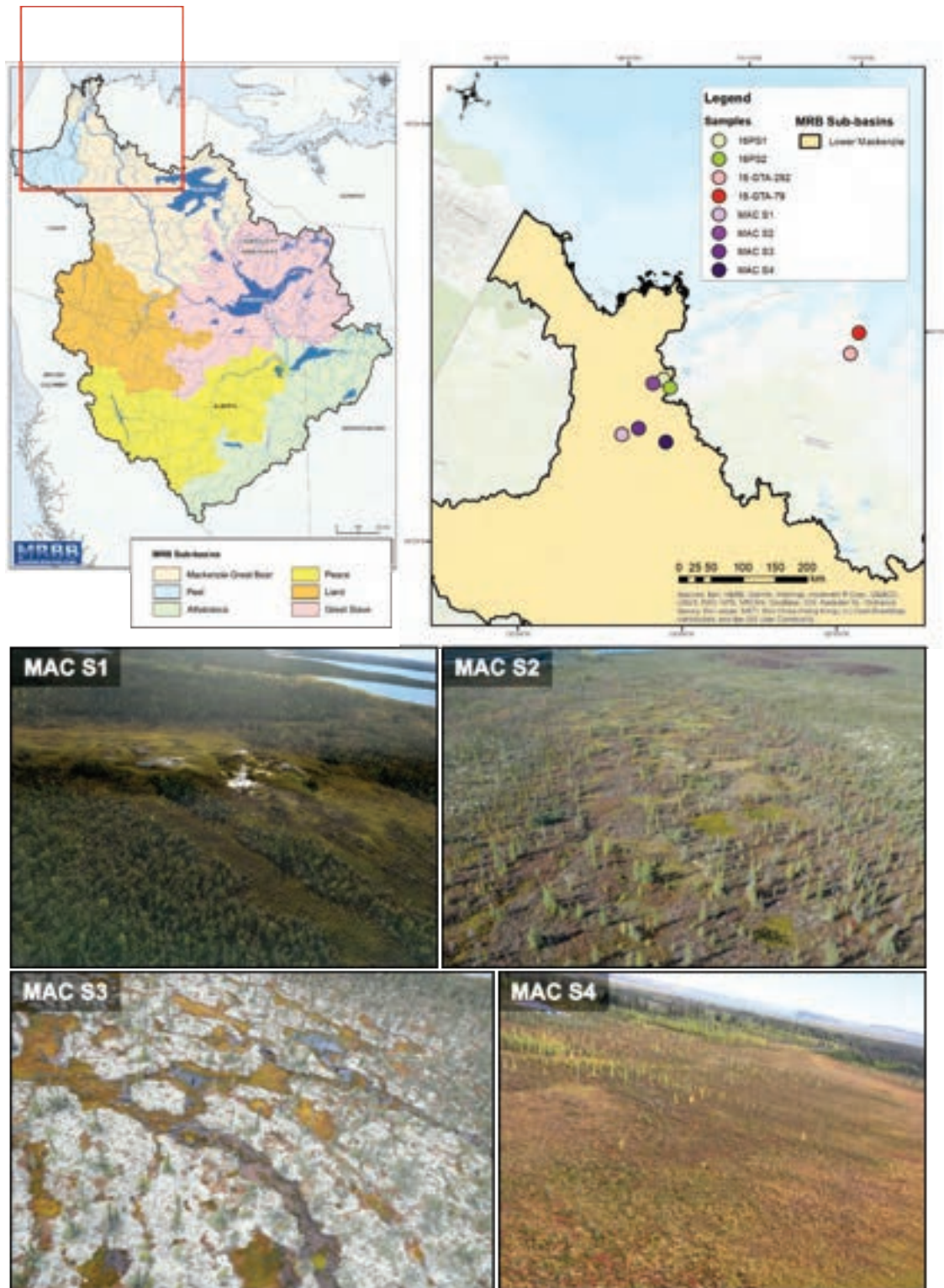

**Figure 1: Map of the MRB and peat core locations. The red box outlines the map boundary on the right. Photo credits: S. Lord, 2020, GRRB. Modified from MRBB and Statistics Canada, EETSD, 2016. MAC S1 – Mackenzie Site 1; MAC S2 – Mackenzie Site 2; MAC S3 – Mackenzie Site 3; MAC S4 – Mackenzie Site 4. GPS coordinates and dates of photos of MAC S1 to MAC S4 shown in Table 1.**

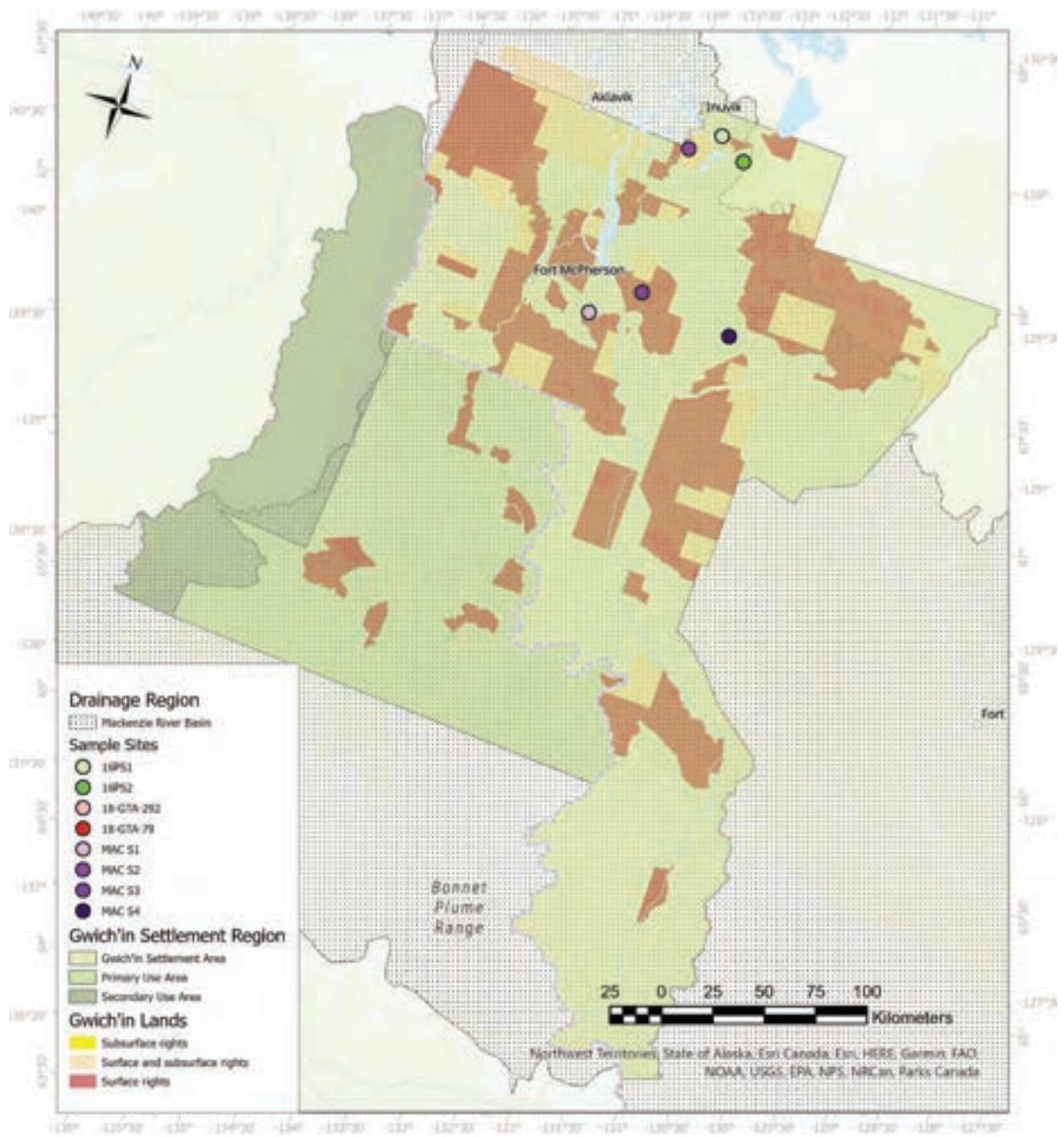

**Figure 2: Gwich'in settlement area (GSA), spanning the Yukon and Northwest Territories. The Gwich'in Tribal Council owns 16,264 km<sup>2</sup> of land throughout the GSA. Approximately 5,100 people live in the GSA. Mapped in Esri ArcGIS Pro 2.8.**

**Table 1: List of peat monoliths/cores, depth, geographical coordinates and collection date.**

<i>Site</i>	<i>Latitude</i>	<i>Longitude</i>	<i>Depth (cm)</i>	<i>Depth after slicing (cm)</i>	<i>Collection Date</i>
<i>16PS1</i>	68.3156 N	133.4338 W	43*	31.5	August 10, 2016
<i>16PS2</i>	68.2430 N	133.0945 W	37.5*	29.5	August 12, 2016
<i>18-GTA-79</i>	69.7733 N	126.7683 W	35	13	July 22, 2018
<i>18-GTA-289</i>	69.4075 N	126.5894 W	39	n/a	July 29, 2018
<i>18-GTA-290</i>	69.4583 N	126.8967 W	29	n/a	July 30, 2018
<i>18-GTA-291</i>	69.4583 N	126.8967 W	23	n/a	July 30, 2018
<i>18-GTA-292</i>	69.4583 N	126.8967 W	22	15	July 30, 2018
<i>MAC S1</i>	67.39813 N	134.12663 W	71	56	August 25, 2020
<i>MAC S2</i>	68.21260 N	133.74426 W	93	78	August 26, 2020
<i>MAC S3</i>	67.56144 N	133.65172 W	91	77	August 27, 2020
<i>MAC S4</i>	67.51628 N	132.55479 W	81	62	August 28, 2020

\*Depth was measured after storage and may be compressed

Six sub-basins comprise the MRB: 1) Athabasca watershed; 2) Great Slave watershed; 3) Mackenzie Main Stem and Great Bear Lake watershed; 4) Peace watershed; 5) Liard watershed; and, 6) Peel watershed (Fig.1).

The majority of peat and vegetation samples were collected from the GSA in the Mackenzie Main Stem and Great Bear Lake watersheds, the largest of the sub-basins in the MRB (Fig. 2). The Mackenzie-Great Bear sub-basin extends for approximately 475,000 km<sup>2</sup>, 26% of the entire MRB. Approximately 7,800 people in 13 communities live within this sub-basin, with Inuvik being the largest community. This sub-basin also includes the Mackenzie Delta, Canada's second largest wetland and the second largest Arctic delta globally. The Mackenzie River, Canada's longest river at 1,800 km in length, discharges approximately 1.787 million km<sup>2</sup> of freshwater into the Arctic Ocean through the Mackenzie Delta and has an estimated annual flow of 10,000 m<sup>3</sup>/s (Rosenberg and Barton, 1986).

The Athabasca watershed encompasses the southernmost tributaries of the Mackenzie River system. Adjacent to the Athabasca watershed is the Peace watershed, which contains the only major inflow in the MRB that is artificially regulated (Rosenberg and Barton, 1986). The Athabasca and Peace rivers move eastward into the Peace-Athabasca Delta at Lake Athabasca and then continue northward as the Slave River. The Slave River discharges into Great Slave Lake (Rosenberg and Barton, 1986). River tributaries from the west (Mackenzie, Liard, Peel rivers) and east (Great Bear River) combine into the Mackenzie River as the system moves northward and eventually discharges into the Beaufort Sea (Rosenberg and Barton, 1986).

Annual precipitation in the MRB can range between 250 – 400 mm to the east of the Mackenzie River, and 500-1600 mm in the mountainous west (Brunskill, 1986). Maximum snow cover in the east averages 500 – 760 mm; in the west, 1020 – 1520 mm. Mean daily temperatures south of Great Slave Lake range between -20°C and -26°C in January and 16 – 21°C in July, whereas mean daily temperatures at Inuvik range between -23°C and -29°C in January and 10 – 16°C in July (Brunskill, 1986). The southern region of the MRB is dominated by boreal forest, with minor alpine tundra at high altitudes in the Rocky Mountains (Brunskill, 1986). Permafrost here occurs in patches or under peat bogs. The northern region of the MRB is dominated by sub-arctic forest, with patches of low Arctic tundra (Brunskill, 1986). Permafrost thickness in the northern

half of the MRB increases northward, with 12 m thickness near Fort Simpson to 60 m at Normal Wells, and then to more than 800 m in the Mackenzie Delta area (Brunskill, 1986).

## METHODS

### Site Selection

#### *Peatland Site Selection*

Peatlands include fens and bogs and are ideal collection sites for surface moss samples and peat cores. Fens are connected to slow flowing water from a system of lakes and streams and have been in contact with nutrient-rich surfaces and/or groundwater. This creates a productive and biologically diverse ecosystem. While bogs store and release water from the surrounding land, these environments are disconnected from lakes and streams and are thus nutrient poor and have lower plant diversity than fens. The surface of bogs may be raised and isolated from mineralized soil waters. Ideal bogs for paleoclimate study are those that are raised high and lack inflows and outflows, indicative of ombrotrophic bogs. The only water source for ombrotrophic bogs is rainwater and snow. Ombrotrophic bogs are ideal for geochemical and micropaleontological analyses as they preserve atmospherically deposited metals as well as microfossils (e.g., testate amoebae).

In both fens and bogs, peat exists in at least 40 cm thick layers. Three general groups exist for fens: 1) graminoid (grasses, sedges) fens without trees or shrubs; 2) shrub fens; and, 3) treed fens. Fens have a higher plant diversity than bogs; peat layers in fens are dominated by black spruce, larch/tamarack, sedges, grasses, and a range of mosses. In comparison, peat layers in bogs are dominated by *Sphagnum* mosses, ericaceous shrubs, and black spruce.

### Peat Core Collection and Sub-sampling

#### *16PS1 & 16PS2 Peat Monoliths*

Peat monoliths 16PS1 and 16PS2 were collected opportunistically close to the road. These monoliths were collected within the GSA and MRB by GSC officers, C. Fish and C. Duchesne, using a “spade and shovel” or “trowel” method near Inuvik and Campbell Lake, respectively (Fig. 3; Table 2).

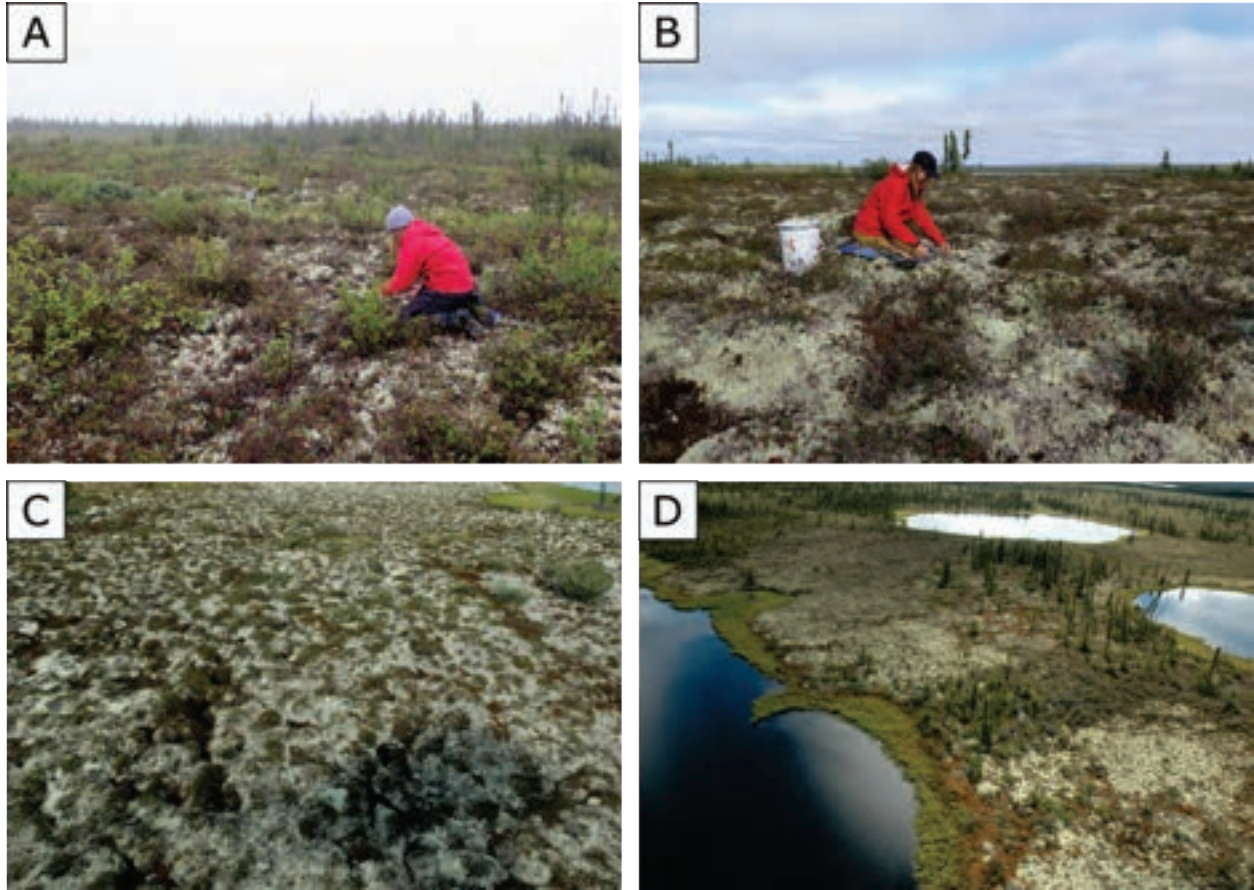

**Figure 3: Site photos of 16PS1 (A) and 16PS2 (B-D). Peat monoliths were collected using a trowel method (A, B). Photo credits: C. Duchesne, Geological Survey of Canada, 2016. NRcan Photo Database Number for Fig. 3A: 2022-387; Fig. 3B: 2022-388; Fig. 3C: 3033-389; Fig. 3D: 2022-390.**

**Table 2: Site metadata for peat monoliths 16PS1, 16PS2. Measurements of each core were taken in 2020 and 2021, after shipping and storage at Carleton University.**

<i>Sample name</i>	<i>Length (cm)</i>	<i>Width (cm)</i>	<i>Height (cm)</i>	<i>Location</i>
16PS1	15.5	11	43	Inuvik, NT
16PS2	17	17	37.5	Campbell Lake, NT

The dimensions of 16PS1 monolith after storage measured 15.5 x 11 x 43 cm (Fig. 4), which was collected to maximum thaw depth of approximately 60 cm. The sample site for 16PS1 was located about 15 m from a small drainage channel in the peatland. 16PS2 measured 17 x 17 x 37.5 cm after storage (Fig. 4) and was collected to maximum thaw depth at approximately 50 cm. The sample site for 16PS2 was located in peatland about 100 m from a water body. 16PS1 and 16PS2 were stored in the Patterson Research Group (PRG) Laboratory (Carleton University) fridge at approximately 4°C. 16PS1 and 16PS2 were unwrapped in 2020 and sub-sampled at contiguous 5 mm intervals using a RYOBI 9-Inch band saw. Sub-samples were washed with distilled water after slicing. Sub-samples have been/will be submitted for radiometric dating,

HAWK pyrolysis, Hg analysis, and paleontological (e.g., plant macrofossils, palynology, testate amoebae) analyses.

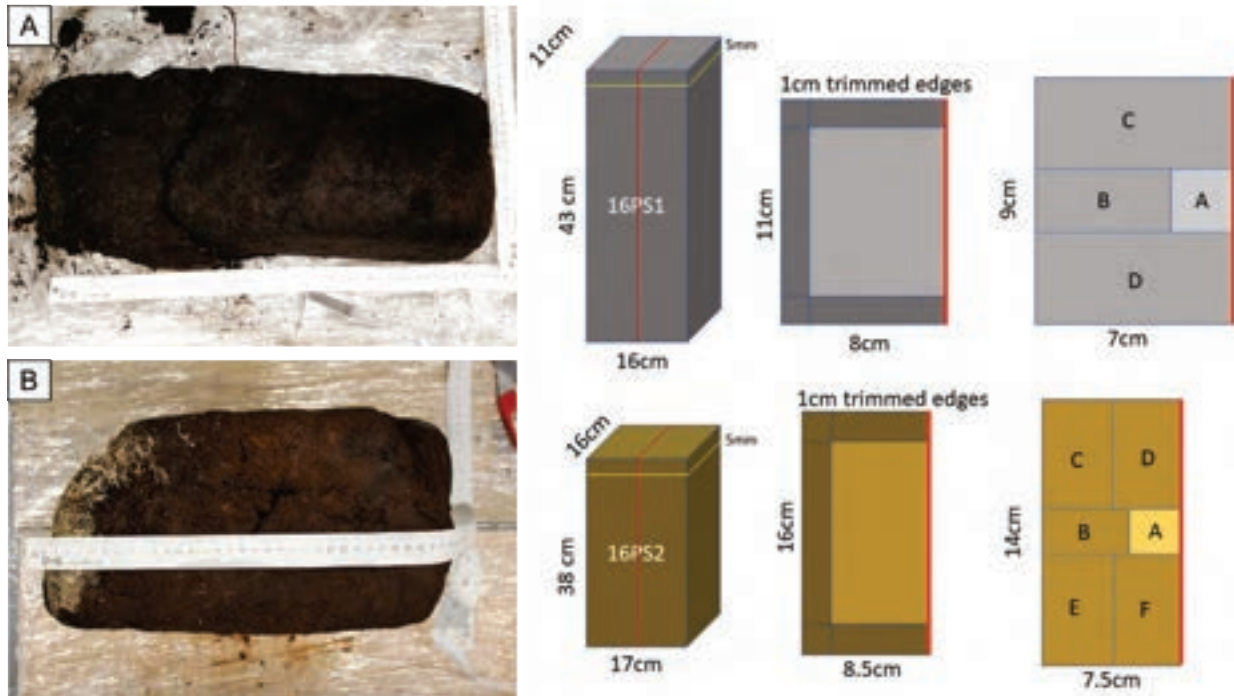

**Figure 4: Peat monoliths and sub-sampling plan for 16PS1 (A) and 16PS2 (B). Monoliths were wrapped in plastic and stored at  $\sim 4^{\circ}\text{C}$  at Carleton University prior to being sub-sampled at contiguous 5 mm intervals. 1 cm was trimmed away from the edges of each 5 mm slice to avoid contamination from the plastic wrap. Half of each monolith is frozen as an archive. Sub-sample Part A was  $2\text{ cm}^3$  and used for testate amoebae analysis. Sub-sample Part B ( $\sim 5\text{ cm}^3$ ) was submitted for HAWK analysis and palynological preparation. Sub-sample Parts C or D ( $\sim 10\text{ cm}^3$ ) were used for radiocarbon dating, plant macrofossil analysis, and/or stable isotope geochemistry. Photo credits: A.V. Nguyen, Carleton University, 2020.**

Approximately  $5\text{ cm}^3$  from 61 sub-samples from 16PS1 and 59 sub-samples from 16PS2 were individually wrapped in aluminium foil and shipped frozen to the Geological Survey of Canada, Calgary, for HAWK pyrolysis and palynological preparation.  $1\text{ cm}^3$  from each  $5\text{ cm}^3$  horizon was allocated for palynological analyses.

Approximately  $3 - 5\text{ cm}^3$  from 60 sub-samples (0 – 300 mm) from 16PS1 were sent to Manchester Metropolitan University, United Kingdom, for stable isotope geochemistry.

Nine sub-samples from 16PS1 and 6 sub-samples from 16PS2 were picked for plant macrofossils for AMS radiocarbon dating (Table 7). The sub-samples from 16PS1 were sent to the 14CHRONO lab, Queen’s University, Belfast (QUB). The sub-samples from 16PS2 were sent to the André E. Lalonde Accelerator Mass Spectrometry (AEL AMS) Laboratory at the University

of Ottawa. An additional 10 sub-samples will be submitted for radiocarbon dating at the AEL AMS laboratory (six from 16PS1 and four from 16PS2).

#### *18-GTA-79 & 18-GTA-292 Peat Monoliths*

Monoliths 18-GTA-79, -289, -290, -291, -292 were collected by GSC officer, J.M. Galloway, using a “spade and shovel” or “trowel” method (Fig. 5; Table 3). Collection of these peat monoliths were opportunistic while conducting geological bedrock mapping and sampling for the Geo-Mapping for Energy and Minerals Program (GEM), Western Arctic Project, Smoking Hills Activity (led by Dr. I. Rod Smith) in 2018. The 18-GTA peat monoliths were collected from the Smoking Hills region of the Northwest Territories, outside both the GSA and the MRB (Fig. 5). Peatlands away from actively fumigating sites and those close to active fumigation were targeted for collection to explore the influence of auto-combustion of the bituminous Upper Cretaceous Smoking Hills Formation on the geochemical composition of recent peat. 18-GTA-79 and -289 were collected from a site without observed fumigation at the time of collection, whereas the peatlands where 18-GTA-290 – 292 were collected from a site experiencing active fumigation at the time of collection.



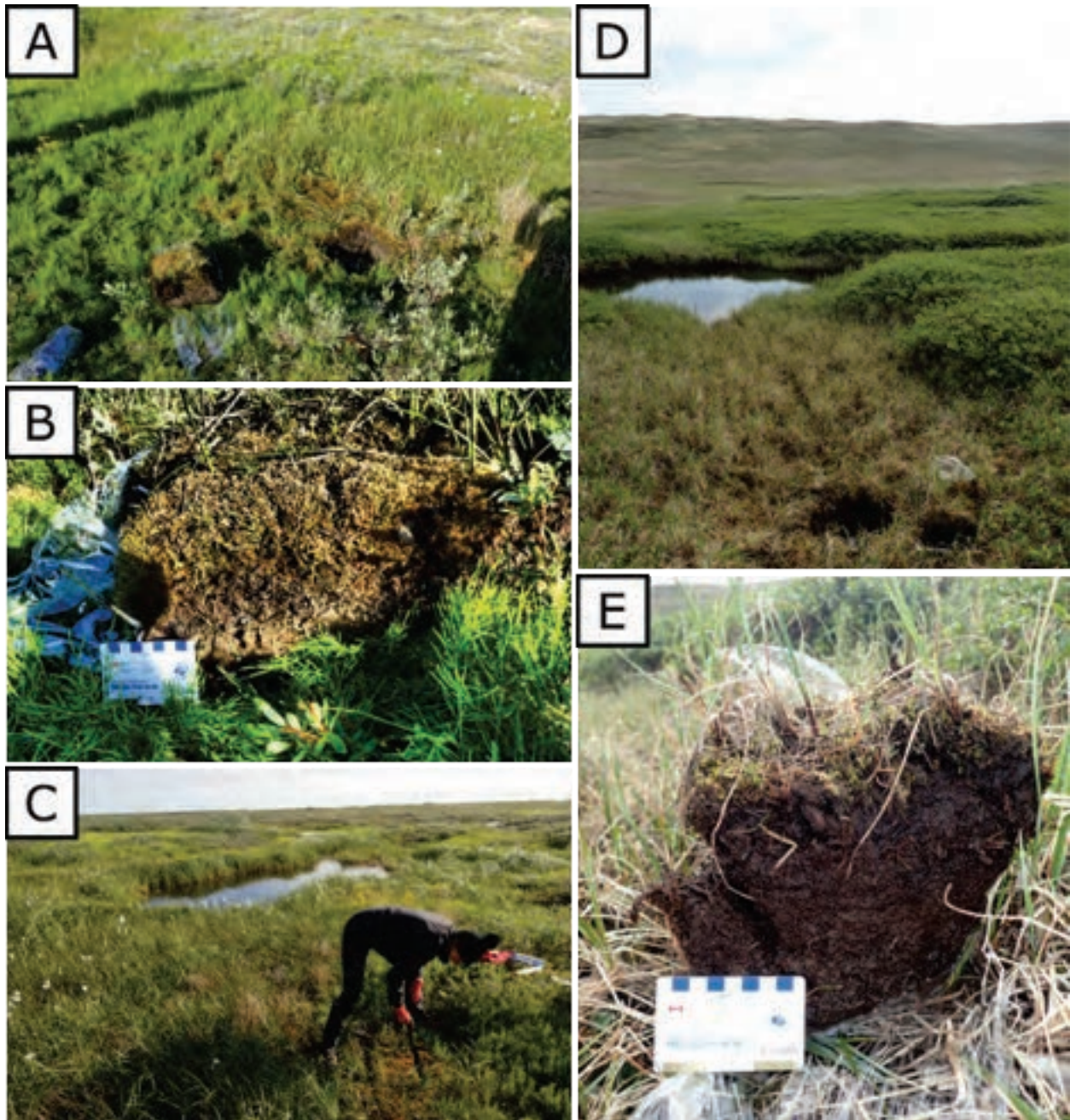
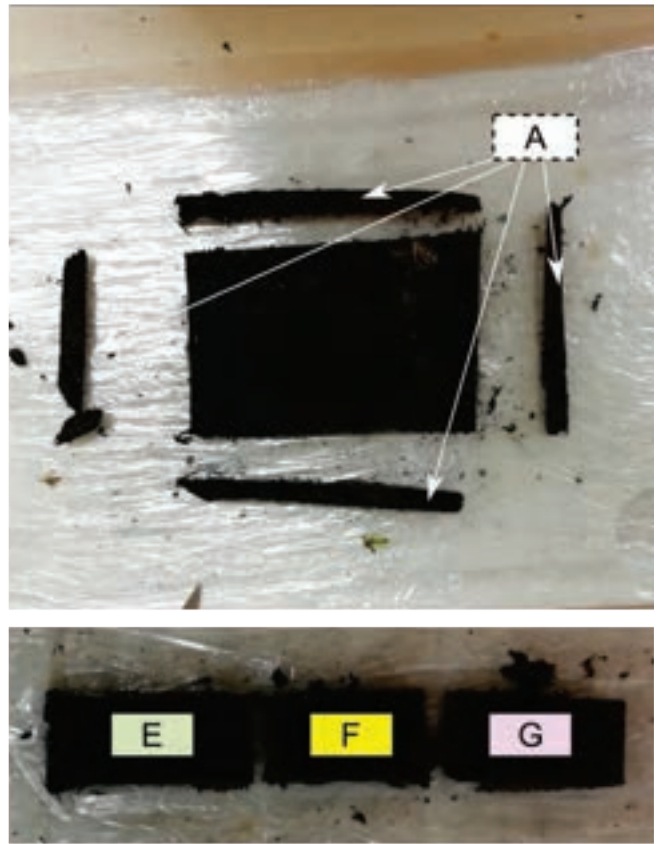
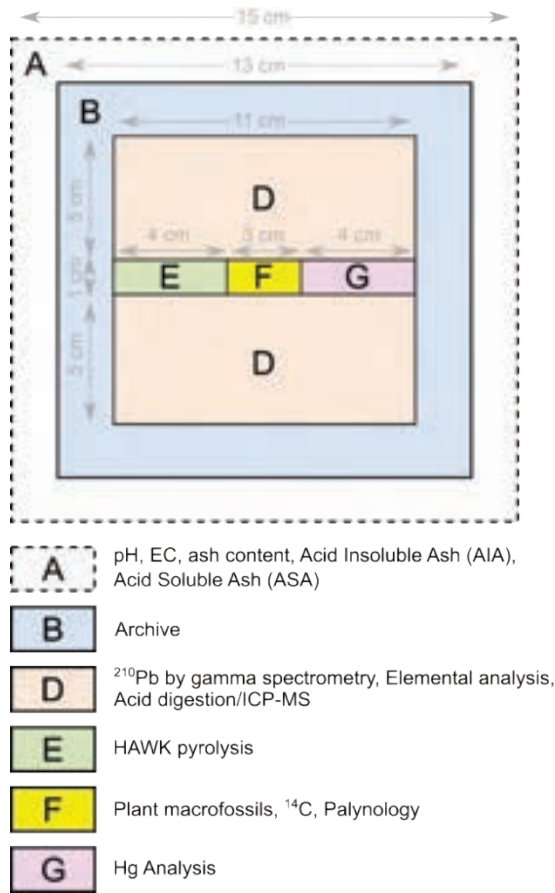

**Figure 5: Site and peat monolith photos for A – C) 18-GTA-292, and D – E) 18-GTA-79. Photo credits: J.M. Galloway, GSC, 2018. NRCan Photo Database Number for Fig. 5A: 2022-391; Fig. 5B: 2022-392; Fig. 5C: 2022-393; Fig. 5D: 2022-394; Fig. 5E: 2022-395.**

**Table 3: Site metadata for peat monoliths 18-GTA-79, -289, -290, -291, -292.**

<i>Sample name</i>	<i>Length (cm)</i>	<i>Width (cm)</i>	<i>Height (cm)</i>	<i>pH</i>	<i>Surrounding vegetation</i>	<i>Fumigation</i>
<i>18-GTA-79</i>	35	21	20	6.32	Arctic cotton, moss, grass	No
<i>18-GTA-289</i>	39	30	24	6.31	Arctic cotton, willow, grass (sedge meadow), peat moss on surface	No
<i>18-GTA-290</i>	29	18	11.5	5.87	Arctic cotton, grass, moss, alder, Labrador tea, cranberry, willow	Actively fumigating
<i>18-GTA-291</i>	23	17	18	6.74	Arctic cotton, grass, moss, alder, Labrador tea, cranberry, willow	Actively fumigating
<i>18-GTA-292</i>	22	17	22	6.25	Arctic cotton, grass, moss, alder, Labrador tea, cranberry, willow	Actively fumigating

Monoliths 18-GTA-290, -291, and -292 were sampled at approximately the same location. 18-GTA-289 was minerogenic rather than peat. Peat monoliths 18-GTA-79 and -292 were therefore selected for detailed study. 18-GTA-79 and -292 were sliced at 1 cm intervals and sub-sampled for geochemistry (e.g., HAWK, ICP-MS, Hg analysis) and paleontology (e.g., plant macrofossils, palynology, testate amoebae) at the SWAMP laboratory at the University of Alberta (Fig. 6).



**Figure 6: Peat core-cutting and sub-sampling protocol devised by the SWAMP laboratory (University of Alberta) for 18-GTA-79, 18-GTA-292 sliced at 1 cm intervals. Photo credits: A. Oleksandrenko, University of Alberta, 2020.**

Sub-samples for ICP-MS and  $^{210}\text{Pb}$  dating (Part D) were processed at the SWAMP Laboratory at the University of Alberta.

Sub-samples from Part E (14 sub-samples from 18-GTA-79, 16 sub-samples from 18-GTA-292) were air dried in the fume hood at the PRG Laboratory, Carleton University, individually wrapped in aluminium foil and packaged in plastic bags, and then sent to the Geological Survey of Canada, Calgary, for HAWK pyrolysis.

Four sub-samples from 18-GTA-79 and 18-GTA-292 were analyzed at the University of Calgary (Petroleum Reservoir Group) by Dr. Thomas Oldenburg and his team and GSC Research Scientist Dr. Jaime Cesar Colmenares. The samples analyzed were 18-GTA-79 0 – 10 cm (including the living layer), 10 – 13 cm and 18-GTA-292 0 – 9 cm (including the living layer) and 18-GTA-292 9 – 15 cm. Following crushing by mortar and pestle and cold solvent extraction using DCM:MeOH at 93:7 ratio, extracted organics were separated into non-polar and polar fractions using C18 solid phase extraction (SPE). The non-polar fraction was then separated into aliphatic and aromatic hydrocarbons using silica SPE. These fractions were analyzed using chromatography-mass spectrometry (GC-MS). The peat sub-samples were also analyzed without

fractionation using Fourier transform ion cyclotron resonance mass spectrometer (FTICR-MS). Results of these analyses will be published elsewhere.

Sub-samples for macrofossil analysis (Part F) were sent to Carleton University for further subdivision for testate amoebae analysis, AMS  $^{14}\text{C}$  dating, and plant macrofossil analysis. Four sub-samples from 18-GTA-79 and 4 sub-samples from 18-GTA-292 were sent to the 14CHRONO lab, Queen's University, Belfast, for AMS  $^{14}\text{C}$  dating. One additional sub-sample from 18-GTA-292 was sent to André E. Lalonde AMS laboratory, University of Ottawa. Two additional sub-samples from 18-GTA-79 are to be submitted for radiocarbon dating at the AEL AMS laboratory.

#### *MAC Site Peats*

Seven peatlands (MAC S1 – 7) were selected for surface moss and vegetation sample collection, depth to water table measurements, and/or coring (Figs. 7 – 12; Table 4). Potential peatland sites in the GSA were selected based on satellite imagery and reconnaissance fly-over and landings during summer 2020. Sites with differing distances from the Mackenzie River were targeted to capture a range of environments and environmental histories. With helicopter support, a crew led by Sarah Lord of the Gwich'in Renewable Resources Board (GRRB) flew and landed to visually select a variety of peatlands between August 25 – 28, 2020 for collection of peat cores, surface moss and vegetation samples (MAC S1 – 4), and between September 18 – 20, 2020 for further collection of surface moss and vegetation samples (MAC S5 – 7). For the collection of surface moss samples, sites were selected for bog surfaces that had live vegetation. Sites that did not have an actively growing layer were avoided as the age of the surface peat layers can be 100's – 1000's of years old. Live vegetation will be green, whereas dead peatlands will be brown/red in colour. In the GSA, 108 surface moss and 108 vegetation samples were collected at seven sites and measured for pH, specific (SP) conductivity, and depth to water table (Figs. 13 – 15; Table 4).



**Figure 7: MAC S1 vegetation (not herein identified). Photo credits: S. Lord, GRRB 2020. See Table 1 for GPS coordinates and dates of photos of MAC S1.**

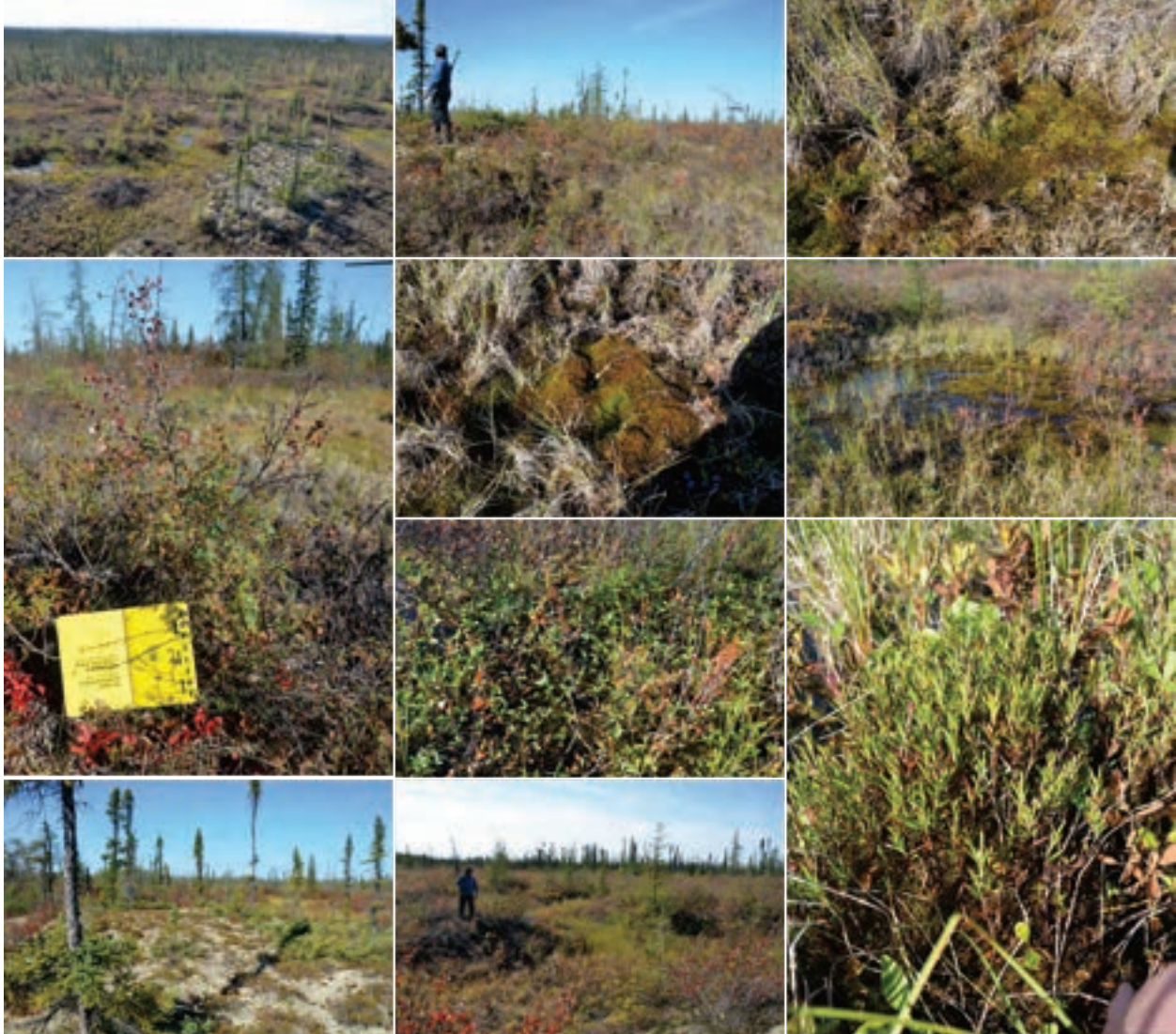

**Figure 8: MAC S2 site and vegetation (not herein identified). Photo credits: S. Lord, GRRB, 2020. See Table 1 for GPS coordinates and dates of photos for MAC S2.**

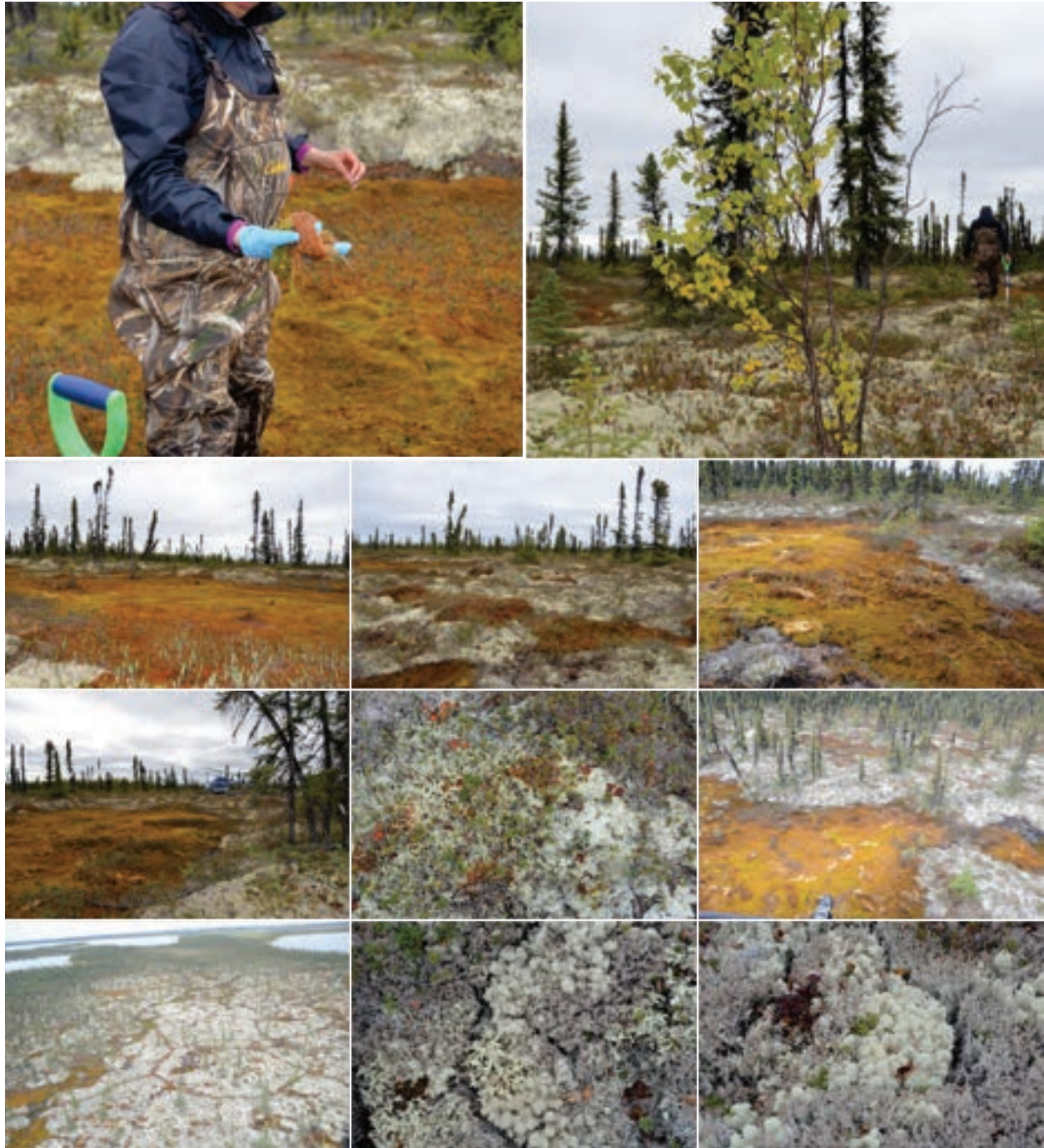

**Figure 9: MAC S3 site and vegetation (not herein identified). Photo credits: S. Lord, GRRB, 2020. See Table 1 for GPS coordinates and dates of photos for MAC S3.**

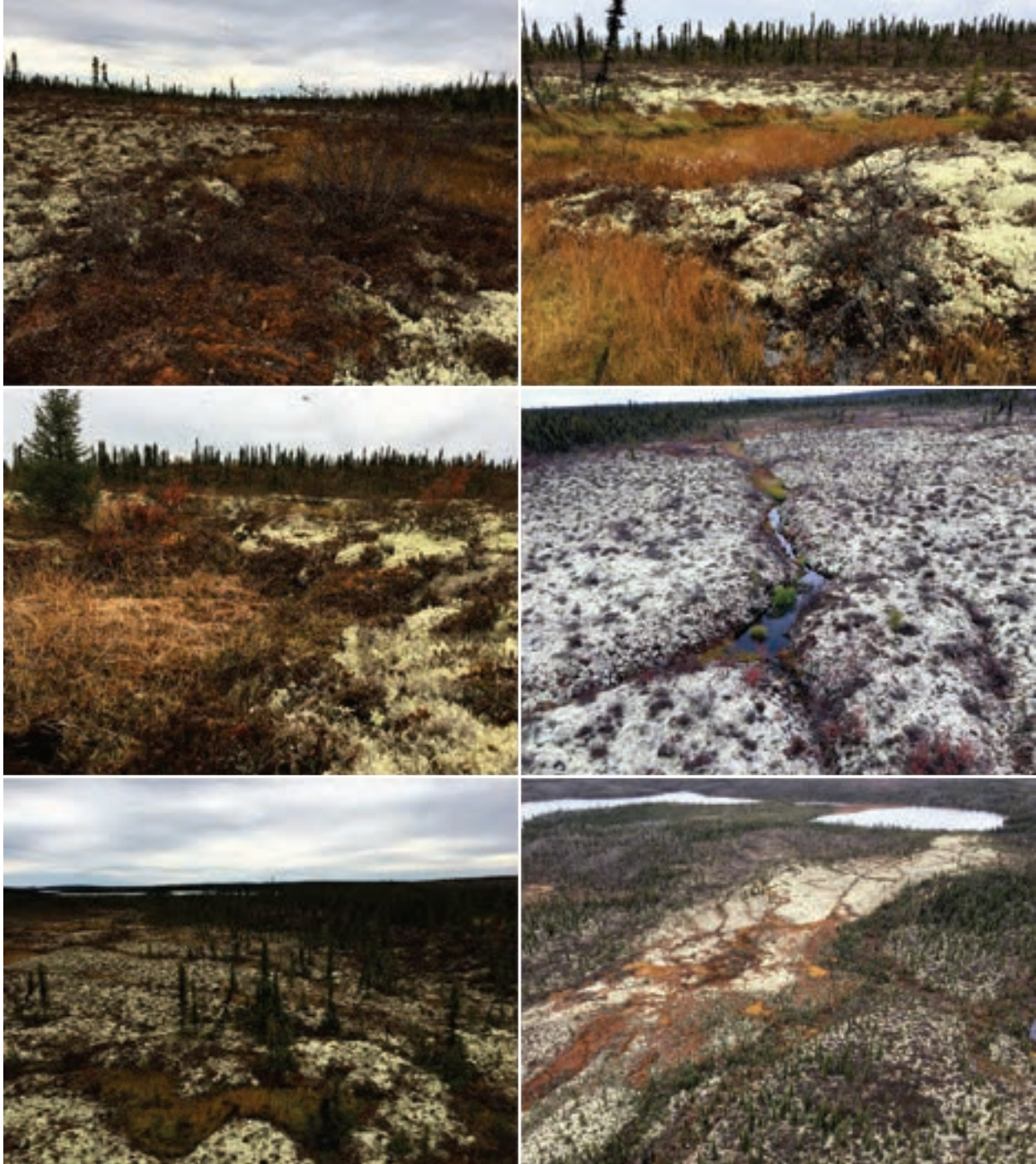
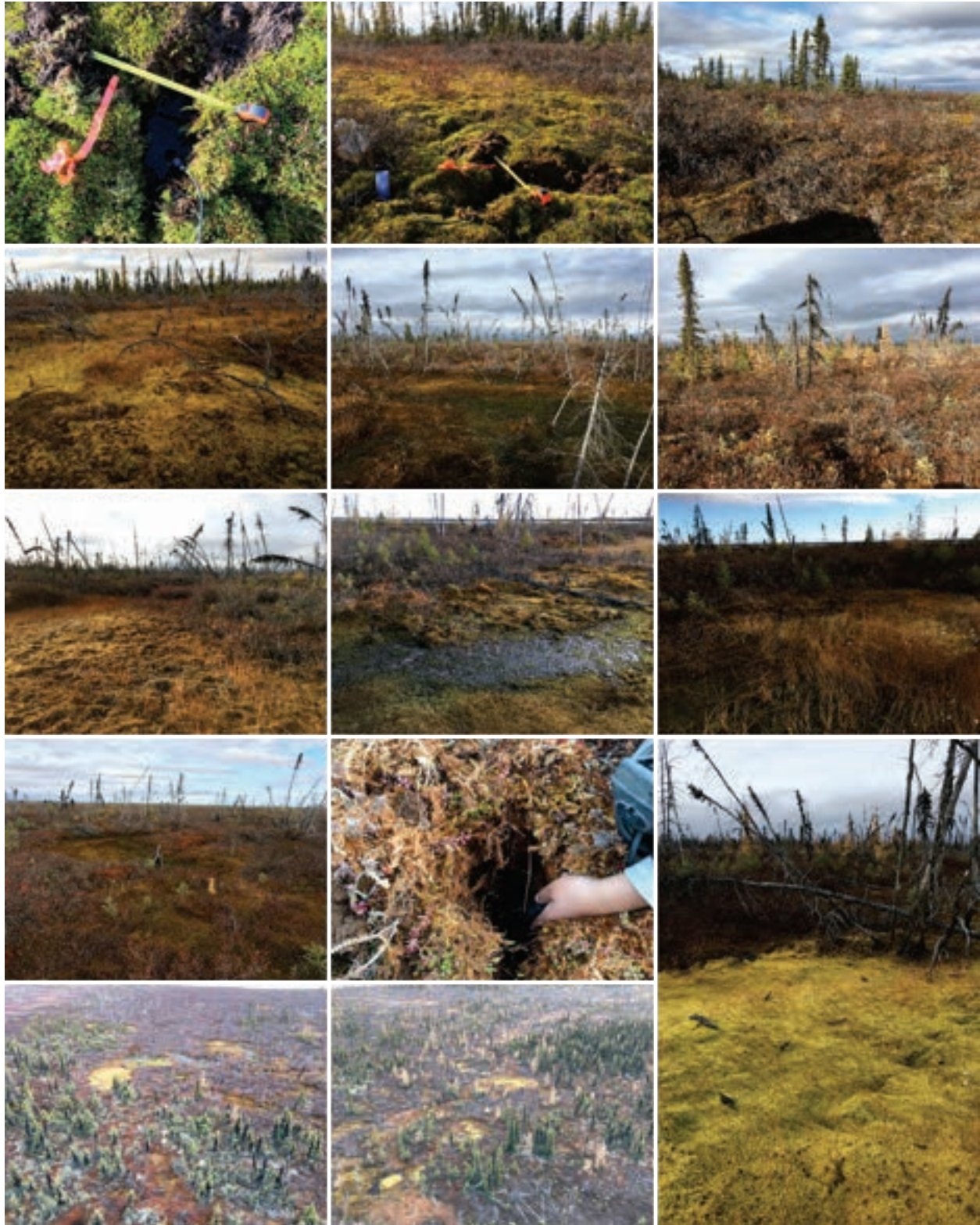

**Figure 10: MAC S5 site and vegetation (not herein identified). Sites 5 – 7 were only used for collecting surface moss and vegetation samples. See Table 5 for GPS coordinates and dates of photos for MAC S5. Photo credits: S. Lord, GRRB, 2020.**

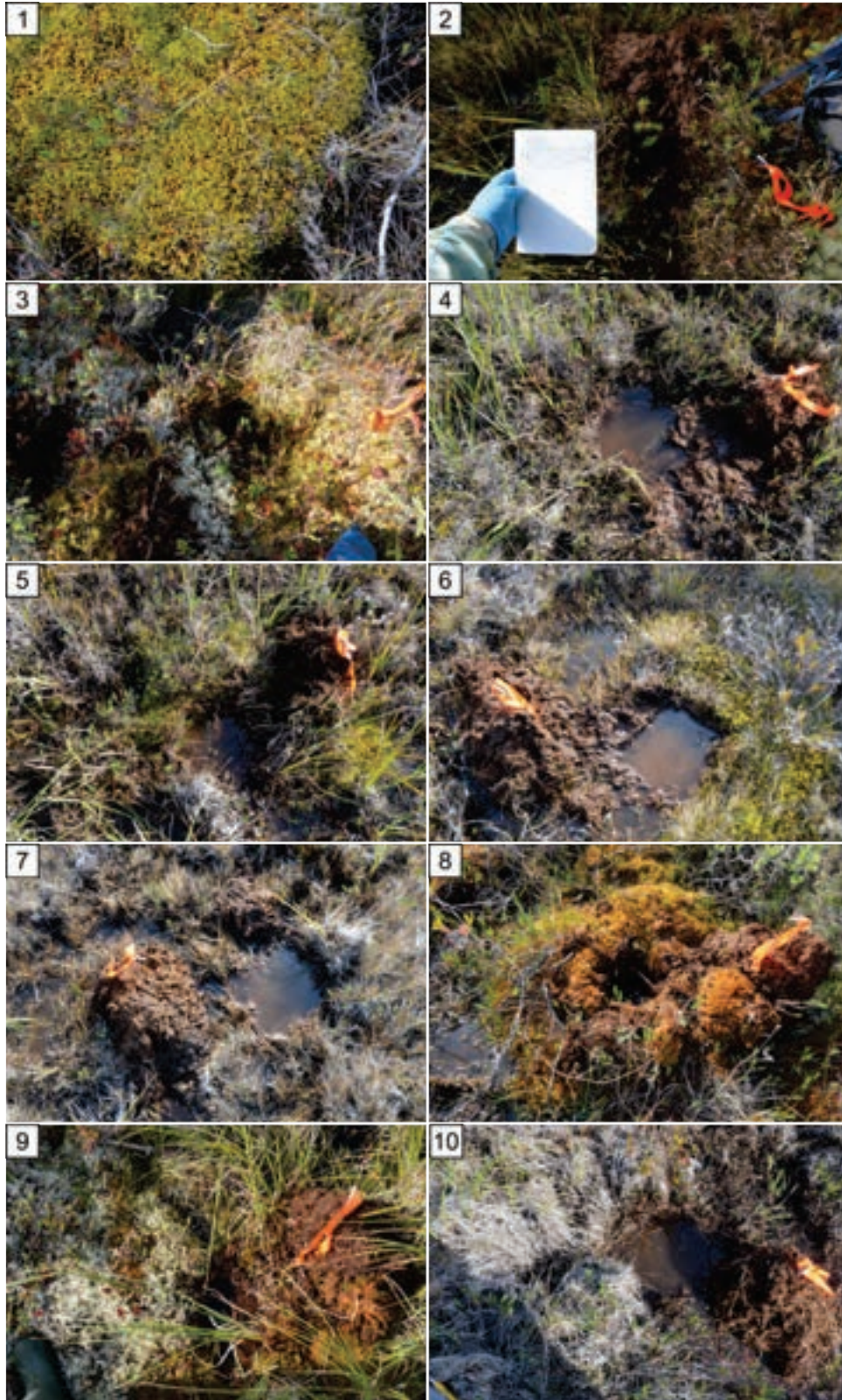



**Figure 11: MAC S6 site and vegetation (not herein identified). See Table 5 for GPS coordinates and dates of photos for MAC S6. Photo credits: S. Lord, GRRB, 2020.**



**Figure 12: MAC S7 site and vegetation (not herein identified). See Table 5 for GPS coordinates and dates of photos for MAC S7. Photo credits: S. Lord, GRRB, 2020**



**Figure 13: MAC S1 surface moss, vegetation, and depth to water table measurements from sample sites 1 through 10 (as labelled). See Table 5 for GPS coordinates and dates of photos for samples from MAC S1. Photo credits: S. Lord, GRRB, 2020.**

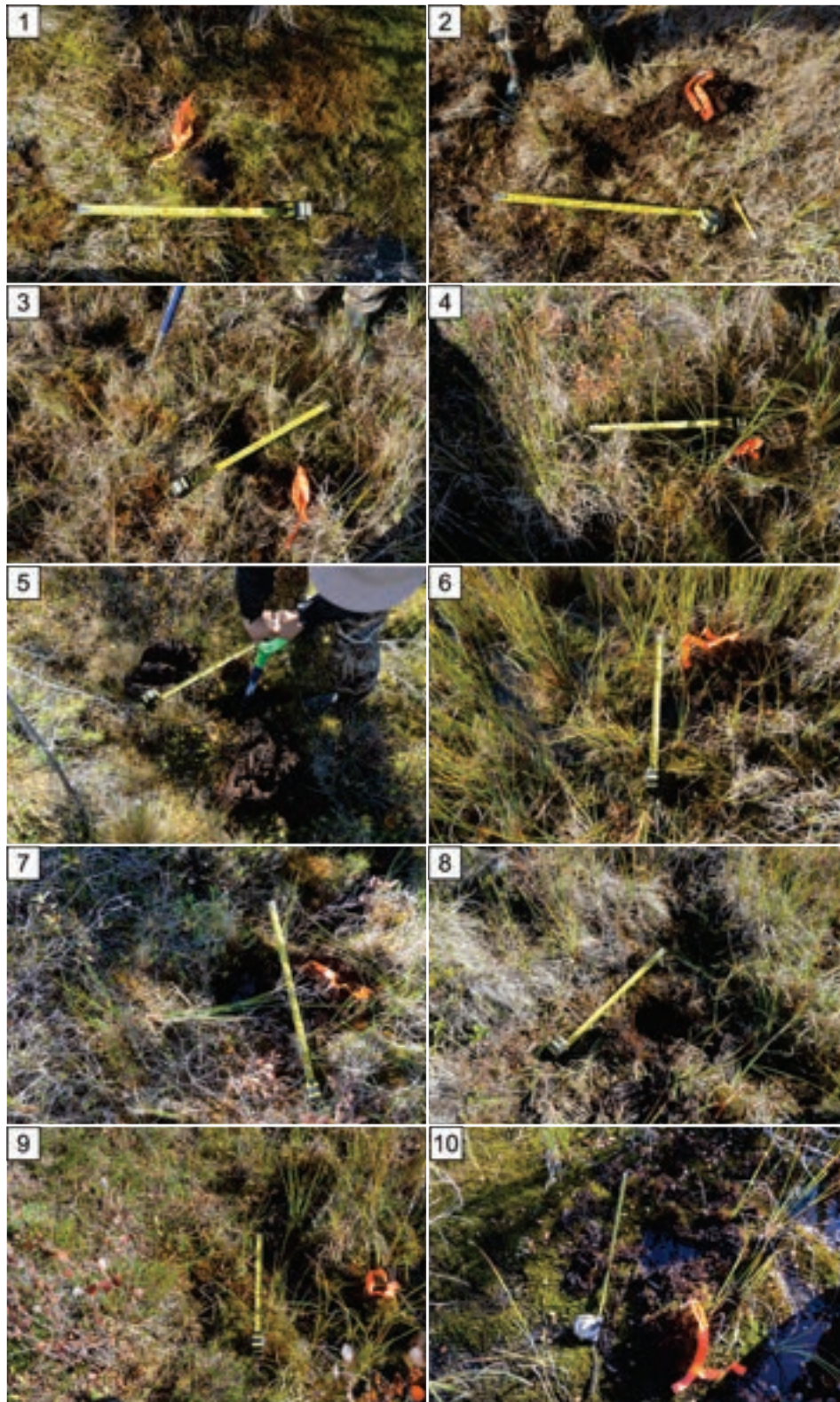

**Figure 14: MAC S2 surface moss, vegetation, and depth to water table measurements from sample sites 1 through 10 (as labelled). See Table 5 for GPS coordinates and dates of photos for samples from MAC S2. Photo credits: S. Lord, GRRB, 2020.**

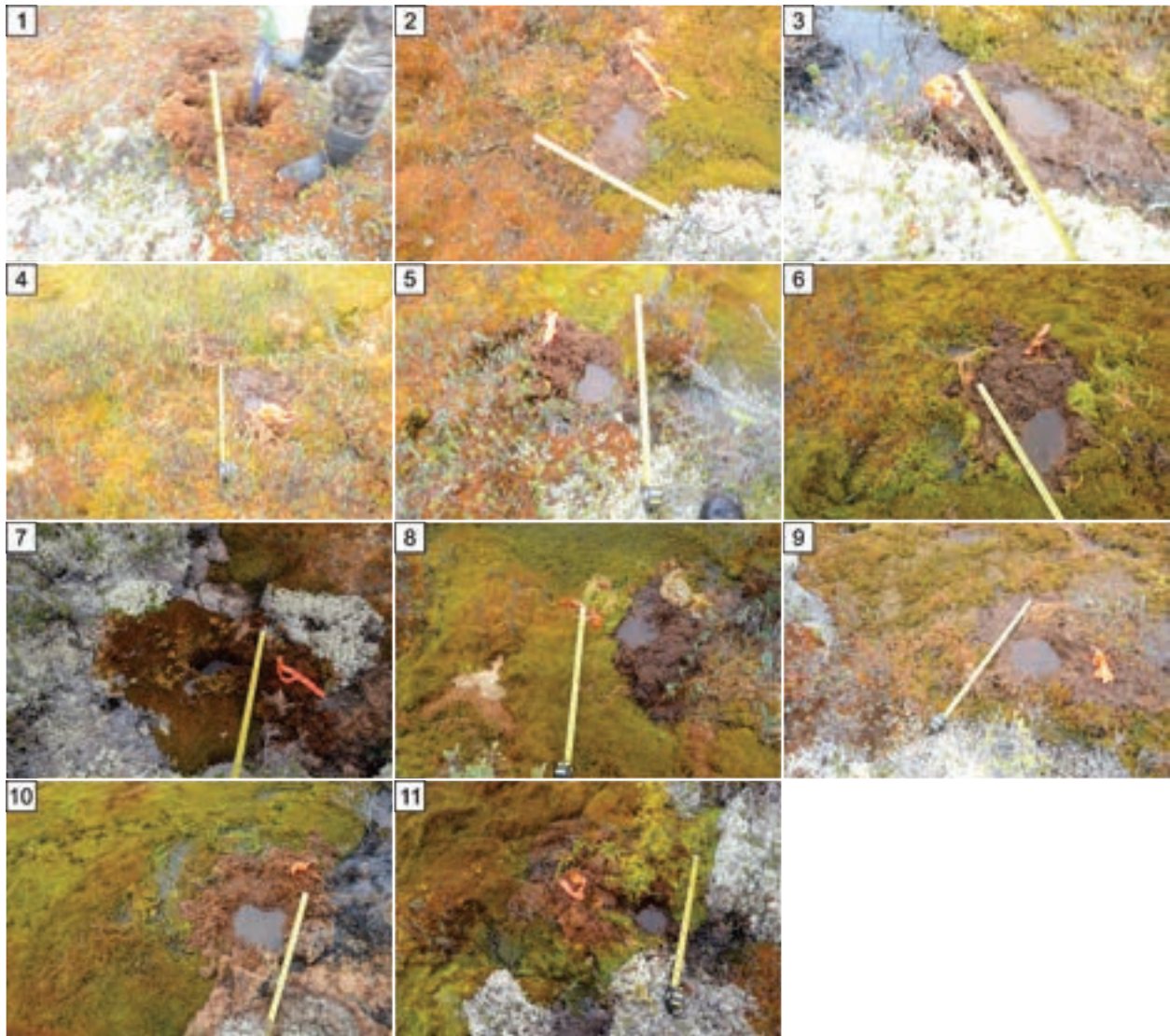

**Figure 15: MAC S3 surface moss, vegetation, and depth to water table measurements from sample sites 1 through 11 (as labelled). See Table 5 for GPS coordinates and dates of photos for samples from MAC S3. Photo credits: S. Lord, GRRB, 2020.**

**Table 4: Moss, vegetation, and depth to water table measurement sites at the MAC S1 – 7 locations and their microform and site descriptions.**

<i>Date</i>	<i>Field team</i>	<i>MAC S</i>	<i>Moss &amp; Vegetation samples</i>	<i>Latitude (N)</i>	<i>Longitude (W)</i>	<i>Vegetation at site</i>	<i>Depth to Water Table (cm)</i>	<i>pH</i>	<i>SP conductivity (µS/cm)</i>	<i>Notes</i>
25-Aug-20	Sarah Lord, Steve Anderson, Jason McLeod	1	1	67.39816	134.12647	Moss, dwarf Labrador tea, sedges	7	5.79	93.6	
			2	67.39822	134.12643	Labrador tea, moss, cranberry, sedges, grass, dwarf birch, cloudberry, cottongrass	10, 18	5.28	51.2	
			3	67.39838	134.1265	Moss, reindeer lichen, cloudberry, large Labrador tea, cranberry, grass, dwarf black spruce	28	4.92	35.2	
			4	67.39884	134.1265	Grass, moss, dwarf Labrador tea	7	5.48	53.9	
			5	67.39815	134.12614	Moss, dwarf Labrador tea, grass, dwarf birch, sedge	5, 10	5.71	81.7	
			6	67.39807	134.12642	Moss, Labrador tea, cottongrass, sedge	5	5.82	65.2	
			7	67.39803	134.1268	Sedge, moss, grass, dwarf Labrador tea	4-8	5.79	65.5	
			8	67.3981	134.12689	Moss, dwarf Labrador tea, birch black spruce, grass, sedge, reindeer lichen	14	4.85	41.2	
			9	67.39793	134.12686	Moss, grass, reindeer lichen, dwarf Labrador tea, cloudberry, cranberry, crowberry	8	4.68	30.4	
			10	67.39803	134.12694	Grass, dwarf Labrador tea, large Labrador tea	8-10	5.61	44.8	
26-Aug-20	Sarah Lord, Julienne Chipesia, Jason McLeod	2	1	68.21241	133.74348	Moss, sedge, grass	5	6.93	365.6	
			2	68.21265	133.74391	Moss, sedge, grass, blueberry	7-8	6.96	346.3	
			3	68.21275	133.74406	Moss, sedge, grass, blueberry	14	6.92	439.2	
			4	68.71281	133.74434	Moss, grass, blueberry, dwarf Labrador tea, birch	2-5	6.69	328.5	
			5	68.21291	133.74458	Moss, dwarf birch, larch, dwarf lab. tea, blueberry, sedge, cloudberry	17, 12, 14	6.87	155.7	
			6	68.21294	133.74498	Moss, sedge, blueberry	1-3	6.71	317.2	
			7	68.213	133.74554	Moss, dwarf Labrador tea, sedge, blueberry, grasses, dwarf birch	10, 22, 12	6.81	261.9	
			8	68.21283	133.74567	Moss, sedge blueberry, dwarf birch, willow shrub, dwarf Labrador tea,	12	6.75	287.3	
			9	68.21266	133.745	Moss, dwarf Labrador tea, dwarf birch, sedge, blueberry, dwarf willow	3-4	6.84	344.1	
			10	68.21261	133.74467	Moss, sedge, grass, dwarf birch	3-5	6.97	343.5	
27-Aug-20	Sarah Lord, Julienne Chipesia, Jason McLeod	3	1	67.56141	133.65155	Moss, reindeer lichen, dwarf Labrador tea, cloudberry, bog rosemary	n/a	n/a	n/a	
			2	67.56152	133.65146	Moss, bog rosemary, dwarf Labrador tea, reindeer lichen	1-3	3.77	81.2	
			3	67.56158	133.65108	Moss, reindeer lichen, dwarf lab. tea, bog rosemary, cloudberry	4-5	3.67	123.8	
			4	67.56166	133.65097	Moss, bog rosemary, sedges, cottongrass	6-7	3.77	81.6	
			5	67.56177	133.65068	Moss, bog rosemary, reindeer lichen, black spruce, cranberry, dwarf Labrador tea, cloudberry	12, 2	3.8	73.2	
			6	67.56174	133.65031	Moss, bog rosemary	6-8	3.8	88.7	
			7	67.5614	133.64996	Moss, cranberry, reindeer lichen, other lichens, cloudberry, bog rosemary, black spruce, dwarf Labrador tea, small vine,	14	3.74	96.3	

					cranberry, black spruce				
		8	67.56125	133.65015	Moss, bog rosemary	5	3.78	82.1	
		9	67.56116	133.65028	Moss, bog rosemary, black spruce, reindeer lichen, cranberry, dwarf Labrador tea, cloudberry	4-5	3.76	82.5	
		10	67.56111	133.65083	Moss, bog rosemary, reindeer lichen	4-5	3.76	91.7	
		11	67.56144	133.65134	Moss, bog rosemary, reindeer lichen, cranberry, cloudberry, dwarf Labrador tea, various other lichen	10-11, 3	3.68	99.3	
28-Aug-20	Sarah Lord, Julienne Chipesia, Jason McLeod	4	1	67.5163	132.55492	Willows, moss, dwarf birch, sedge, dwarf birch, spruce seedling, soapberry	3-4	6.82	887
		2	67.51625	132.55496	Moss, grass, willow, soapberry, dwarf birch	5, 9 if dig	7.15	167.4	
		3	67.51617	132.55495	Spruce seedling, moss, willow, grass, soapberry, dwarf Labrador tea, dwarf birch, burned spruce	19	7.13	83	
		4	67.51611	132.55489	Moss, willow, blueberry, soapberry, bog flower, spruce seedlings, fireweed, hummock grass, sedge	8 but 23 to top of next hummock	6.97	152.1	
		5	67.51617	132.55518	Moss, blueberry, , willow, soapberry, spruce, burned spruce, grass, sedge	6-9	6.73	153.1	
		6	67.51623	132.55533	Moss, soapberry, willow, grass, tamarack, 5-finger, birch, cranberry	16-18	6.61	172.1	
		7	67.51626	132.55534	Moss, willow, soapberry, sedge, grass	16 but 46 if measured from high point of next hummock	6.58	153.3	
		8	67.51634	132.55534	Moss, dwarf birch, blueberry, grass, burned spruce	9-12	6.67	142.3	
		9	67.51643	132.55525	Moss grass, cinquefoil, willow, fuzzy leaf, spruce seedling, tamarack, vetch, firewood, cranberry, mushroom	21, 20, 18	6.51	292.8	
		10	67.51634	132.55504	Moss, willow, birch, blueberry, grass, sedge, burned spruce, soapberry, spruce seedling	10, 30	6.55	511	
18-Sep-20	Sarah Lord, Justin Frost, Charlie Snowshoe Jr.	5	1	67.81902	132.83165	Moss, lichen, Labrador tea, bog rosemary, crowberry, cloudberry, sedges, cranberry	5, 7, 5	5.28	104
		2	67.81895	132.83185	Moss, cloudberry, Labrador tea, lichen, sedge, dwarf birch, dwarf spruce, cranberry, bog rosemary	39, 42, 38	5.08	97	
		3	67.81888	132.83192	Moss, spruce, sedge, cranberry, Labrador tea, cloudberry, blueberry, dwarf birch	0, 2, 1	5.82	106.2	
		4	67.81881	132.83159	Moss, lichen, dwarf birch, Labrador tea, blueberry, cloudberry	45, 43, 48	4.33	101	
		5	67.81883	132.83141	Moss, lichen, cranberry, crowberry, sedge, Labrador tea, cloudberry, dwarf birch	48, 40, 38	4.53	92	
		6	67.81862	132.83096	Moss, lichen, sedge, bog rosemary, cloudberry, crowberry, dwarf birch	11, 13, 9	4.8	101	
		7	67.81846	132.83055	Moss, cloudberry, Labrador tea, cranberry, blueberry, lichen spruce	38, 39, 41	4.16	112	
		8	67.81859	132.83009	Moss, lichen, cranberry, dwarf birch	36, 39, 40	4.09	106	
		9	67.81833	132.82973	Moss, sedge, lichen, cloudberry, dwarf birch, blueberry, bog rosemary, dwarf willow	5, 5, 3	5.18	95	
		10	67.81835	132.82941	Moss, cloudberry, lichen, dwarf spruce, willow, Labrador tea, sedge, cranberry, bog rosemary	30, 32, 29	4.76	119	
		11	67.81816	132.82903	Moss, Labrador tea, cloudberry, blueberry, crowberry, lichen, cranberry, dwarf birch, bog rosemary, grass	23, 25, 18	4.54	112	
		12	67.81807	132.8288	Moss, lichen, crowberry, cloudberry, blueberry, Labrador tea	36, 33, 36	4.31	124	
		13	67.81813	132.82855	Moss, grass	1, 2, 3	5.15	108	

			14	67.81826	132.82828	Moss, lichen, crowberry, willow, bog rosemary, cloudberry, Labrador tea, grass	12, 13, 15	4.47	101	
			15	67.81838	132.82828	Moss, lichen, dwarf birch, cloudberry, cranberry	9, 7, 8	4.17	102	
			16	67.81845	132.82855	Moss, lichen, cloudberry, crowberry, Labrador tea	8, 4, 4	4.17	105	
			17	67.81848	132.82896	Moss, lichen, cranberry, Labrador tea, cloudberry, grass, bog rosemary, crowberry	6, 12, 8	5.32	106	
			18	67.81866	132.82919	Moss, cloudberry, willow, dwarf birch, Labrador tea	4, 9, 9	5.34	115	
			19	67.81878	132.82945	Moss, cranberry, spruce, Labrador tea, cloudberry, blueberry, grass, dwarf birch	11, 10, 6	4.75	109	
			20	67.81884	132.82977	Moss, grass, lichen, cranberry, cloudberry, Labrador tea	11, 15, 9	4.23	107	
19-Sep-20	Sarah Lord, Charlie Snowshoe Jr., Justin Frost	6	1	67.98801	133.1534	Moss, sedge/grass	7, 5, 2	5.3	197	
			2	67.98791	133.15338	Moss, Labrador tea, grass/sedge, cloudberry, dwarf birch	20, 19, 18	5.56	168	
			3	67.98777	133.15356	Moss, lichen, soapberry, dwarf birch, grass	18, 16, 18	5.53	158	
			4	67.98769	133.15395	Moss, lichen, spruce, Labrador tea, cloudberry, cranberry	46, 41, 41	n/a	n/a	No water
			5	67.98753	133.15436	Moss, Labrador tea, lichen, soapberry, bog rosemary, cloudberry, cranberry, dwarf	25, 18, 24	5.22	123	
			6	67.98748	133.15475	Moss, grass	3, 3, 4	4.86	165	
			7	67.98761	133.15489	Moss, lichen, soapberry, Labrador tea, cloudberry	32, 29, 27	5.08	117	
			8	67.98779	131.15527	Moss, lichen, Labrador tea, soapberry, cloudberry, cranberry	23, 22, 18	5.22	85	
			9	67.98798	133.15488	Moss, lichen, Labrador tea, soapberry, dwarf birch, cranberry	35, 33, 33	n/a	n/a	No water
			10	67.98807	133.15466	Moss, Labrador tea, dwarf birch, blueberry, lichen	29, 28, 20	n/a	n/a	No water
			11	67.98811	133.1537	Moss, grass, soapberry, Labrador tea, cranberry	4, 7, 2	5.01	185	
			12	67.98833	133.1539	Moss, grass, bog rosemary, dwarf birch, soapberry, grass	23, 22, 16	5.37	134	
			13	67.98837	133.15433	Moss, cloudberry, grass, soapberry, blueberry, bog rosemary	27, 26, 25	5.26	22	
			14	67.98835	133.15446	Moss, lichen, soapberry, grass, Labrador tea, cranberry, blueberry, dwarf birch	39, 36, 34	n/a	n/a	No water
			15	67.98829	133.15471	Moss, grass, willow, soapberry, dwarf birch	8, 6, 10	5.57	117	
			16	67.98836	133.15501	Moss, grass, dwarf birch, soapberry, Labrador tea, bog rosemary	13, 14, 13	4.94	33	
			17	67.98849	133.15515	Moss, grass, dwarf birch, willow	10, 6, 7	5.38	23	
			18	67.98849	133.15547	Moss, sedge, dwarf birch, bog rosemary	31, 28, 26	5.45	127	
			19	67.98854	133.15546	Moss, grass, soapberry, Labrador tea, cloudberry, bog rosemary, cranberry	30, 33, 31	5.5	97	
			20	67.98856	133.15512	Moss, lichen, dwarf birch, soapberry, spruce, Labrador tea, bog rosemary	34, 33, 28	5.66	112	
			21	67.98849	133.15468	Moss, grass, soapberry	8, 8, 6	5.63	112	
			22	67.98847	133.15446	Moss, dwarf birch, soapberry, bog rosemary, grass, willow	31, 27, 21	5.59	46	
			23	67.98842	133.15416	Moss, dwarf birch, bog rosemary, grass	33, 34, 34	5.63	83	
			24	67.98819	133.15376	Moss, grass	13, 12, 12	5.7	247	



		25	67.98811	133.1535	Moss, grass, soapberry, bog rosemary	22, 24, 18	5.56	173		
20-Sep-20	Sarah Lord, Justin Frost, Charlie Snowshoe Jr	7	1	67.76755	133.64815	Moss, cloudberry, grass/sedge	17, 22, 19	4.27	n/a	
			2	67.76743	133.64908	Moss, grass/sedge, Labrador tea, cloudberry cranberry, soapberry	28, 26, 29	4.75	n/a	
			3	67.76733	133.64813	Moss, Labrador tea, dwarf birch, spruce, cranberry, bog rosemary, soapberry, lichen	53, 27, 29	4.17	n/a	
			4	67.7672	133.64807	Moss, lichen, Labrador tea, cranberry, spruce, cloudberry, lichen	46, 43, 44	n/a	n/a	No water
			5	67.7671	133.64821	Moss, lichen, dwarf spruce, cranberry, Labrador tea, cloudberry, soapberry	51, 50, 46	n/a	n/a	No water
			6	67.76694	133.64839		9, 8, 8	4.11	n/a	
			7	67.76678	133.64847	Moss, spruce, Labrador tea	22, 17, 18	4.04	n/a	
			8	67.76678	133.64847	Moss, grass/sedge, Labrador tea, bog rosemary, lichen, cranberry	36, 29, 31	4.62	n/a	
			9	67.76662	133.64868	Moss, cranberry, Labrador tea, cloudberry	19, 20, 18	3.99	n/a	
			10	67.76652	133.64864	Moss, Labrador tea, cloudberry, cranberry, grass/sedge	31, 29, 28	3.96	n/a	
			11	67.76644	133.64871	Moss, spruce, lichen, Labrador tea, cranberry, cloudberry	56, 55, 55	4.25	n/a	
			12	67.76634	133.64871	Moss, spruce, Labrador tea, bog rosemary, cranberry	14, 12, 15	3.98	n/a	
			13	67.76626	133.64964	Moss, spruce, grass/sedge, cranberry, bog rosemary, Labrador tea	28, 27, 26	3.89	n/a	
			14	67.76617	133.64854	Moss, dead (burned) spruce, soapberry	8, 7, 4	3.9	n/a	
			15	67.76604	133.64882	Moss, soapberry, grass/sedge, bog rosemary	31, 29, 30	3.93	n/a	
			16	67.76595	133.54896	Moss, Labrador tea, spruce, cranberry, cloudberry	36, 33, 37	3.88	n/a	
			17	67.7658	133.6432	Moss, spruce, Labrador tea, soapberry, tamarack, bog rosemary, cloudberry	7, 5, 5	4.08	n/a	
			18	67.76575	133.64891	Moss, bog rosemary, spruce, Labrador tea, soapberry,	22, 24, 21	3.91	n/a	
			19	67.76572	133.64862	Moss, soapberry	5, 11, 6	4.02	n/a	
			20	67.76582	133.64822	Moss, Labrador tea, spruce, cranberry, lichen, cloudberry, bog rosemary, grass/sedge	31, 27, 29	3.92	n/a	
			21	67.76594	133.64812	Moss, bog rosemary, spruce, soapberry, grass/sedge, Labrador tea	30, 29, 38	4.16	n/a	
			22	67.76614	133.64842	Moss, Labrador tea, cranberry, tiny vine, soapberry, spruce, cloudberry	45, 44, 41	4.08	n/a	

The MAC cores were collected using a Wardenaar-type titanium corer that was designed and built by researchers at the SWAMP lab (Shotyk and Noernberg, 2020; Fig. 16; Table 5). Standard peat extraction techniques used are described in De Vleeschouwer et al. (2010). The MAC peat cores were shipped in wooden boxes and frozen as soon as possible after collection (by end of each collection day at the latest) at approximately -20°C. Laboratory measurements for pH, electrical conductivity (EC), and total dissolved solids (TDS) was taken using a Hanna HI98129 Combo pH/Conductivity/TDS tester at each site.

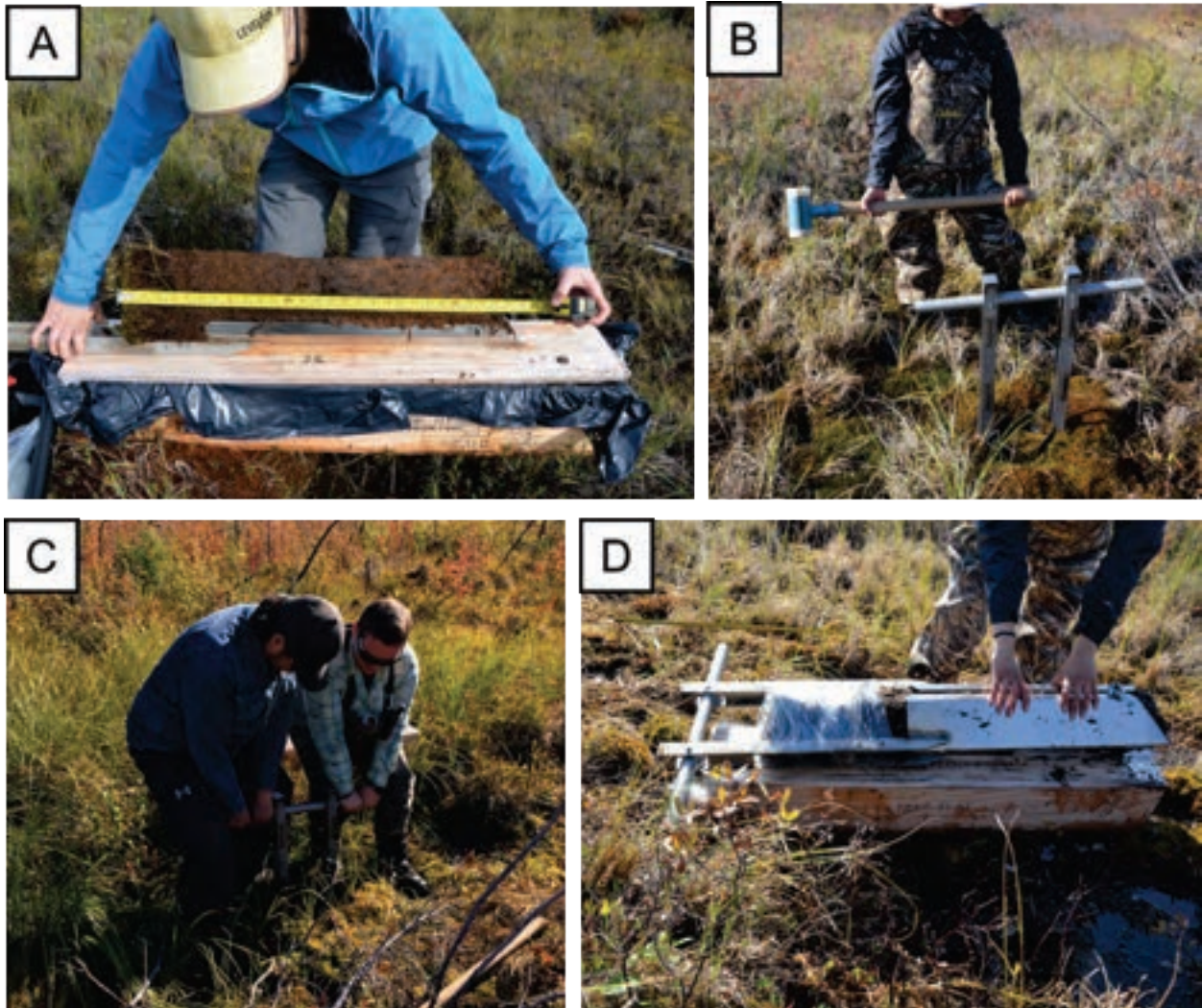

**Figure 16: Site photos from the collection of the MAC cores by the GRRB team in 2020. A) Steve Anderson (GRRB) measuring Site 1 Core 1, B) Julienne Chipesia (GRRB) using the SWAMP lab-designed titanium corer, C) Sarah Lord and Jason Blake McLeod (GRRB) using the titanium corer, D) Julienne Chipesia extracting Site 2 Core 1. Photo credits: S. Lord, GRRB, 2020.**

**Table 5: Metadata from MAC cores including GPS coordinates, site description, core measurements, and site measurements.**

Core	Site Description	Length (cm)	Width (cm)	Height (cm)	Depth to Water Table (cm)	pH	SP conductivity	Elevation (m ASL)
MAC S1	Floating bog. High water table.	71	20	17	6	5.65	54.9	69
MAC S2	Bog patterned, near to river.  Vegetation: Moss, sedge, dwarf birch, one willow seedling, surrounded by black spruce and reindeer lichen. Dwarf Labrador tea, crowberry, cloudberry, blueberry, <i>Arctostaphylos rubra</i> , larch.	93	n/a	n/a	2-4	6.81	494.1	73
MAC S3	Open and flat site.  Vegetation: Reindeer lichen, moss (more orange than other sites ), dwarf Labrador tea, cranberry, black spruce, cloudberry, "bog rosemary"	91	21	16		3.8	91.1	107
MAC S4	Site is close to a creek and nearby trees.  Vegetation: Moss, grass (tall with tiny cattails), cottongrass, dwarf birch, willow shrubs, spruce seedlings, burned old spruce, small soapberry, <i>Arctostaphylos rubra</i> , cinquefoil	81 (longest part, 75 for main body)	21	16	7, 3	6.75	741	208

Sub-sampling and preparation of the peat cores took place at the SWAMP laboratory at the University of Alberta, a Class 100 000 laboratory with high efficiency particulate air (HEPA) filters that minimizes the risk of contamination of the samples from dust in ambient air.

For each core, the living layer was cut away from the peat. The thickness of the living layer was estimated from the boundary between vegetation and peat (Fig. 17). This boundary was determined visually based on colour differences and represents 0 cm depth.

Each core was cut into 1 cm slices using a food-grade, stainless steel bandsaw (the OMEGA SO200 bandsaw) equipped with roller bearings constructed of stainless steel (420 steel) with 1 mm thickness at the SWAMP laboratory at the University of Alberta. Sub-samples were sliced on a polypropylene table to avoid metal contamination, the surface of which was covered in new plastic wrap for each individual slice. The methodology for slicing sub-samples was modified from Givélet et al. (2004): a commercially available knife with a plastic handle and a high-quality stainless-steel blade (Kershaw Knife Model 1280 GE) was used to sub-divide each 1 cm slice into 6 parts (A – G; Fig. 17).

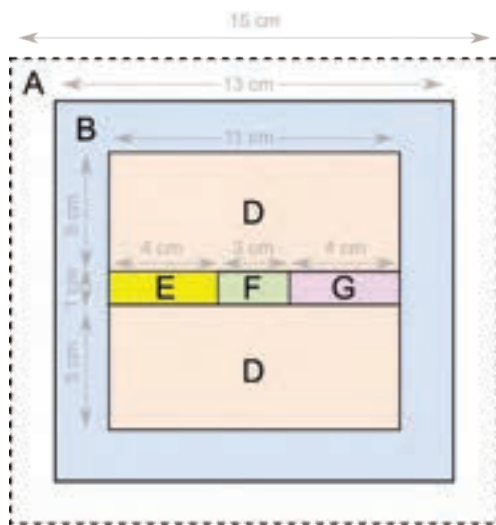

- A** pH, EC, ash content, Acid Insoluble Ash (AIA), Acid Soluble Ash (ASA)
- B** Archive
- D** <sup>210</sup>Pb by gamma spectrometry, Elemental analysis, Acid digestion/ICP-MS
- E** Plant macrofossils, <sup>14</sup>C, Palynology
- F** HAWK pyrolysis
- G** Hg Analysis



**Figure 17: Slicing and sub-sampling protocol devised by the SWAMP laboratory, University of Alberta for MAC cores sliced at 1 cm intervals and showing division of living layer from peat. Photo credit: A. Oleksandrenko, University of Alberta, 2020.**

Sub-samples for ICP-MS and  $^{210}\text{Pb}$  dating (Part D) were processed at the SWAMP laboratory, University of Alberta.

Sub-samples for macrofossil analysis (Part E) were sent to Carleton University for further subdivision for testate amoebae analysis and AMS  $^{14}\text{C}$  dating. One sub-sample from MAC S1, MAC S2, and MAC S4 and 10 sub-samples from MAC S3 were submitted to the 14CHRONO lab, Queen's University, Belfast. Seven sub-samples from MAC S1, 7 from MAC S2, and 6 from MAC S4 were submitted to the AEL AMS laboratory, University of Ottawa. Additional sub-samples will be submitted for radiocarbon dating (two from MAC S1, two from MAC S2, nine from MAC S3, and five from MAC S4) to the AEL AMS laboratory. After retaining material for testate amoebae (1  $\text{cm}^3$ ) and AMS  $^{14}\text{C}$  dating, the remaining material (277 sub-samples) was shipped frozen to M. Gałka at the University of Łódź, Poland, for plant macrofossil analysis. Sub-samples for HAWK pyrolysis (Part F) were sent to the Geological Survey of Canada, Calgary.

### Depth to Water Table Measurements

Collecting data from an environmental gradient was needed to provide a holistic reconstruction of the hydrology of the MRB. Site selection for depth to water table measurements relies on sampling a gradient of peatland ecosystem microtopography (i.e., hummocks and hollows) to capture a range of microenvironments and the taxa that live in them. Depth to water table was measured using a measuring tape extending from ground level to the surface of the groundwater that was exposed after creating a shallow borehole (Fig. 18).



**Figure 18: Julienne Chipesia (top left) and Charlie Snowshoe Jr (top right, bottom) measuring water table depth, pH, and specific conductivity. Photo credits: S. Lord, GRRB, 2020.**

## Plant Macrofossils and Radiometric Dating

Plant macrofossils can be used to provide qualitative insight on vegetation change and past permafrost dynamics (Gałka et al., 2018). Plant macrofossils and macroscopic charcoal enumeration from 277 sub-samples from the MAC cores were analyzed by M. Gałka at the University of Łódź, Poland, following standard techniques. Approximately 2 – 12 cm<sup>3</sup> of material per sub-sample were disaggregated with boiling water for 10 minutes (Gałka et al., 2017a; 2017b), sieved using a 125 micron sieve (Mauquoy and Van Geel, 2007), and washed with and stored in distilled water away from excess light with a few drops of 10% HCl added to prevent mold. For isolation of plant macrofossils, sub-samples were placed in Petri dishes with enough distilled water to float plant material; suitable macrofossils were picked using a stereoscopic Leica S9i microscope (10 – 50x magnification).

Plant macrofossils can also be used for establishing peat chronologies. Accelerator Mass Spectrometry (AMS) <sup>14</sup>C dating is a technique for dating material between 500 – 50,000 years old (Piotrowska et al., 2011). Seventy-two sub-samples were processed for isolation of plant macrofossils for radiocarbon dating. Of those sub-samples, 56 yielded radiocarbon dates. An additional 30 sub-samples will be processed and submitted for radiocarbon dating.

Suitable macrofossils for radiometric dating include non-aquatic mosses to avoid producing anomalous ages (i.e., hardwater effect). Moss and stem leaves were temporarily mounted on glass microscope slides and photographed at 100 – 400x magnification in order to identify the plant macrofossils to the genus or species level. All four MAC cores are dated using <sup>210</sup>Pb chronologies, a technique that determines the ages of material with a temporal accuracy within the last approximate 200 years. The CRS (constant rate of <sup>210</sup>Pb supply) model is currently being applied for <sup>210</sup>Pb dating as it is effectively used for dating ombrotrophic peat bogs (Appleby and Oldfield, 1978; Appleby et al., 1988; Appleby, 1998).

## Palynology

In conjunction with plant macrofossil and testate amoebae analysis, palynological analyses (the study of organic-walled microfossils; pollen, spores, algae) will be used to provide information on vegetation change, which can be affected by changes in climate, fire regime, hydrology, and permafrost dynamics (e.g., Huntley, 1990; Rozema et al., 2006; Leroyer et al., 2015; Swindles et al., 2020). Palynology and plant macrofossils will be used to qualitatively reconstruct regional paleotemperatures, past precipitation rates, fire occurrence, and changes in vegetation.

Palynological samples (n = 398) are permanently curated and stored at the Geological Survey of Canada, Calgary. Samples are being prepared at the GSC Calgary Palynology Laboratory using standard preparation techniques, including maceration with KOH, and HCl where necessary, oxidative treatment with Schulze's solution as necessary, and staining resulting slurries with Safranin O. Palynological residues will be placed on glass microscope slides and permanently mounted with liquid bioplastic. Taxa will be assessed according to the ecological tolerances of their parent plants to generate data on changes in terrestrial vegetation throughout time.

### Testate Amoebae Analysis

Testate amoebae (TA) are biological indicators sensitive to climatic and ecological change and can be used to track hydrological variations and their underlying cause (Barber, 1982, 1985; Charman, 2001). These microbes are single-celled protists that have been extensively used for reconstructing hydrological changes in peatlands as they are ubiquitous, have exceptionally well-preserved shells in the sedimentary record (Tolonen, 1986; Mitchell et al., 2008; Smith et al., 2008), and they respond predictably to changes in water table depth (Booth, 2008). The compositions of TA species assemblages therefore characterize specific environmental and hydrological conditions, pH, moisture, and water table depth in peatlands (Charman and Warner, 1992; Woodland et al., 1998; Booth, 2008; Markel et al., 2010; Mitchell et al., 2013). These protozoans reproduce quickly and are thus sensitive indicators of environmental change (Schönborn, 1992; Wanner and Meisterfeld, 1994).

Testate amoebae assemblages preserved in the surface moss samples will be statistically calibrated to depth to water-table measurements at the collection sites. This data from the MRB will be added to an existing pan-Arctic transfer function (Amesbury et al., 2018). This improved dataset may be used to generate a transfer function specific to the MRB to quantitatively reconstruct changes in water-table depth through time (Swindles et al., 2015; Taylor et al., 2019). Models will be produced using multivariate analyses, such as Non-metric Multidimensional Scaling (NMDS), to identify possible ocean-atmosphere sources influencing TA data composition (Oksanen et al., 2015). The developed transfer functions will be tested using an independent and modern dataset, and subsequently compared with published models.

Peat material (2 cm<sup>3</sup>) was retained from each horizon for TA analysis. Sub-samples (n = 429) were processed for TA analysis using standard extraction techniques (e.g., Booth et al., 2010), including disaggregation of organic material in boiling water for 10 minutes and sieving through 300 µm and 10 µm sieves. Sieving using the 10 µm sieve was facilitated using vacuum filtration. Material between the 300 µm and 10 µm sieves were retained. The isolated TA will be temporarily mounted on microscope slides and enumerated to 100 – 150 counts (Payne and Mitchell, 2009) when possible using high-powered transmitted light microscopy. Scanning Electron Microscopy (SEM) analysis may be necessary to confirm identification of some taxa.

### Mercury (Hg) Analysis & Inductively Coupled Plasma Mass Spectrometry (ICP-MS)

Peat cores from ombrotrophic bogs are ideal archives of high-quality climatic and environmental signals: ombrotrophic bogs are hydrologically isolated — their only source of water is precipitation — and thus preserve atmospherically deposited metals, including Hg and Pb (Shotyk et al., 1998; Weiss et al., 1999; Shotyk, 2002; De Vleeschouwer and Shotyk, 2010; Poto et al., 2015). Non-ombrotrophic bogs will include metal accumulation from ground water and connected surface waters. Increasing Arctic temperatures and subsequent permafrost thaw has the potential to release Hg stored in soils and/or permafrost back into the environment (Yang et al., 2016; Fahnestock et al., 2019). Mercury is of high concern given its ability to transform into an organic and neurotoxic form of methylmercury (Morel et al., 1998; Mergler et al., 2007; Barkay et al., 2011; Lehnher et al., 2012). Currently, 59 sub-samples from 16PS1, 57 sub-samples from 16PS2, and 277 sub-samples from MAC S1-4 are being analyzed for Hg using thermal decomposition at the Geological Survey of Canada, Dartmouth, Nova Scotia.



ICP-MS is a multi-element analytical technique with low detection limits used to generate high resolution data on major and trace elements, such as heavy metal (e.g., Ag, Pb, Cd) concentrations. ICP-MS can provide accurate chemical time series from peat cores (Shotyk et al., 2002; Krachler et al., 2002, 2003; Krachler and Shotyk, 2004; Poto et al., 2015) and is the most widely used technique for peat geochemical analyses, including speciation detection and trace elemental analysis, due to its selectivity, sensitivity and multi-element/isotope capabilities (Caruso and Montes-Bayon, 2003; Moldovan et al., 2004). Multicollector (MC-) ICP-MS is used for highly precise isotope ratio analysis by detecting and measuring multiple isotopes at the same time (Moldovan et al., 2004). Isotopic ratios determined from MC-ICP-MS can help elucidate isotopic fractionation processes in biogeochemical cycles and distinguish between sources and sinks of potentially hazardous compounds and trace elements (Moldovan et al., 2004).

A total of 180 sub-samples from the 18-GTA-79, -292 peat monoliths and MAC S1 – 4 cores were submitted and processed for ICP-MS analysis at the SWAMP lab at the University of Alberta.

All sub-samples allocated for ICP-MS from the GTA monoliths were analyzed. The following sub-samples from each MAC core were analyzed by ICP-MS:

- a. Living layer
- b. 0 – 3 cm depth (3 sub-samples = 0 – 1 cm, 1 – 2 cm, 2 – 3 cm).
- c. For deeper layers, every second sub-sample were analyzed.
- d. Bottom sample (last sample in each core).

### Carbon Isotope Analysis

Boreal and sub-arctic peatlands contain one-third of the world's soil organic carbon while covering only 2% of the land (Gorham, 1991). Peatlands are large carbon storages, stabilizing organic carbon by decreasing degradation, maintaining anoxic conditions, and decreasing temperatures at depth or from permafrost (Dorrepaal et al., 2009). Arctic amplification has been shown to accelerate emissions of CO<sub>2</sub> via respiration of peat deposits, inducing a positive carbon cycle-climate feedback mechanism: an approximate warming of 1°C can increase respiration rates by 60% in the spring and 52% in the summer, an acceleration that can extend for at least eight years (Dorrepaal et al., 2009). Climatic warming may also cause lowering of water table depth, peat oxidation, and permafrost thaw (Gorham, 1991; Schuur et al., 2009). Increased permafrost thaw, in turn, causes accelerated rates of peatland degradation.

Stable carbon isotope analysis can be used to track environmental changes in a peat profile. Peat profiles characterized by aerobic degradation will record an increase in carbon isotopes ( $\delta^{13}\text{C}$ ) with depth, whereas peat profiles characterized by low degradation or anoxic conditions can generate relatively uniform carbon isotope profiles (Alewell et al., 2011). A decrease in carbon isotope values may indicate an enrichment of recalcitrant organic substances during anaerobic mineralisation (Alewell et al., 2011).

Approximately 3 – 5 cm<sup>3</sup> at each horizon (n=60) from the 16PS1 peat monolith are being analyzed at Manchester Metropolitan University for carbon isotope analysis.

## HAWK Pyrolysis

HAWK pyrolysis was used to characterize the type and source of organic matter of peat and carbon accumulation in peatlands. Pyrolysis refers to the decomposition of organic matter by heating samples in an inert atmosphere and combusting them. The released hydrocarbons and carbon dioxide are then measured by flame-ionization and infrared detection to assess the type of organic matter (Lafargue et al., 1998; Sebag et al., 2006). HAWK pyrolysis can determine the quantity of free hydrocarbon present in the sample (S1 carbon), the volume of hydrocarbons formed during pyrolysis (S2 carbon), the yield of carbon dioxide released during thermal cracking of oxygen-bearing organic compounds (S3 carbon), and residual carbon in the sample (S4 carbon). In addition to normal pyrolysis, HAWK can determine total organic carbon (TOC) through a separate oxidation step.

All sub-samples from each horizon per peat monolith/core were air dried, wrapped in aluminum foil to avoid plastic contamination, and submitted to the GSC-Calgary laboratories for HAWK pyrolysis. Between 6.5 – 43.6 mg per sub-sample from all cores underwent pyrolysis and oxidation to determine the amount of free hydrocarbons (S1; mg HC/g) released at 300°C; kerogen-derived hydrocarbon from algal-cell wall lipids (S2; mg HC/g) released at 650°C (Sanei et al., 2005); amount of carbon dioxide during kerogen pyrolysis (S3), which determines the oxygen index; and residual carbon (S4). The S1 and S2 fractions are measured using flame-ionization, whereas the S3 fraction, which includes S3CO<sub>2</sub> (mg CO<sub>2</sub>/g) and S3CO (mg CO/g), are measured by infrared spectroscopy during pyrolysis (Carrie et al., 2012). Following pyrolysis, residual carbon (S4CO; mg-CO/g and S4CO<sub>2</sub>; mg-CO<sub>2</sub>/g) is oxidized in a second chamber and measured by infrared detectors. Total organic carbon (TOC; wt%) is equal to the sum of all organic carbon released during HAWK pyrolysis.

## RESULTS

The project’s methodological approach includes AMS <sup>14</sup>C and <sup>210</sup>Pb age dating, testate amoebae analysis, HAWK pyrolysis, plant macrofossil analysis, ICP-MS geochemical determination on peat and surface moss and vegetation samples, and stable isotope geochemistry (Table 6; Appendix B).

**Table 6: List of number of samples submitted for the analyses described in this project. See also Appendix B. Numbers listed for AMS <sup>14</sup>C indicate samples with returned radiocarbon dates.**

ANALYSES	16PS1	16PS2	18-GTA-79	18-GTA-292	MAC S1	MAC S2	MAC S3	MAC S4	MAC S5	MAC S6	MAC S7
AMS <sup>14</sup> C	9	6	4	5	8	8	9	7			
Plant macrofossils					57	79	78	63			
Palynology	61	59			57	79	78	63			
Quantitative downcore testate amoebae analyses	63	59	14	16	57	79	78	63			
Surface moss samples for quantitative testate amoebae analyses and ICP-MS					10	10	11	10	20	25	22

Hg analysis	59	57			57	79	78	63			
ICP-MS			16	16	31	42	41	34			
Vegetation samples for geochemical determination by ICP-MS					10	10	11	10	20	25	22
Stable isotope analysis	60										
HAWK pyrolysis	61	59	14	16	57	79	78	63			

### Measurements for pH, TDS, and EC

Measurements for pH, total dissolved solids (TDS) and electrical conductivity (EC) are available for the MAC cores (Fig. 19). In order to measure pH, EC, and TDS, peat material was manually squeezed into a plastic bag and extracted pore water was collected into a plastic beaker. This pore water was then measured using a Hanna HI98129 Combo pH/Conductivity/TDS tester. Equipment was cleaned and dried between analyses. The tester was calibrated before analysis of MAC S1 and MAC S4 and tested with a referenced calibration solution after each site to minimize error. For pH measurements, only MAC S3 has pH values lower than 4, suggesting that MAC S3 is the only site that represents an ombrotrophic peatland. Values for pH are also available for the 18-GTA cores, although all have pH > 5 (Table 4).

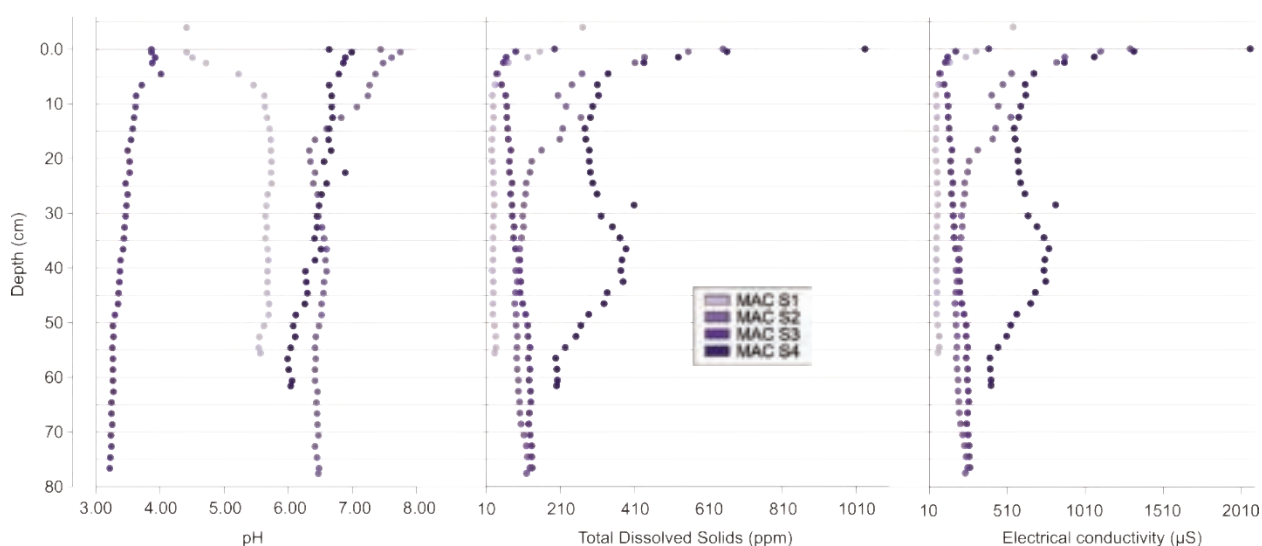

**Figure 19: Compiled data for pH, TDS, EC for MAC cores S1 – 4.**

### Plant Macrofossils & Radiocarbon Dating

*Sphagnum* mosses were preferentially selected when available (Fig. 20; Table 7). When absent, non-aquatic mosses were chosen for submission to radiocarbon dating. *Sphagnum* was present in every core/monolith with the exception of the 18-GTA-79, -292 monoliths. Where plant macrofossils were not present or sparse in the sub-sample, a bulk sample was submitted instead. 61 dates were submitted, and 56 radiocarbon dates were returned, 13 of which had “greater than modern” returns.

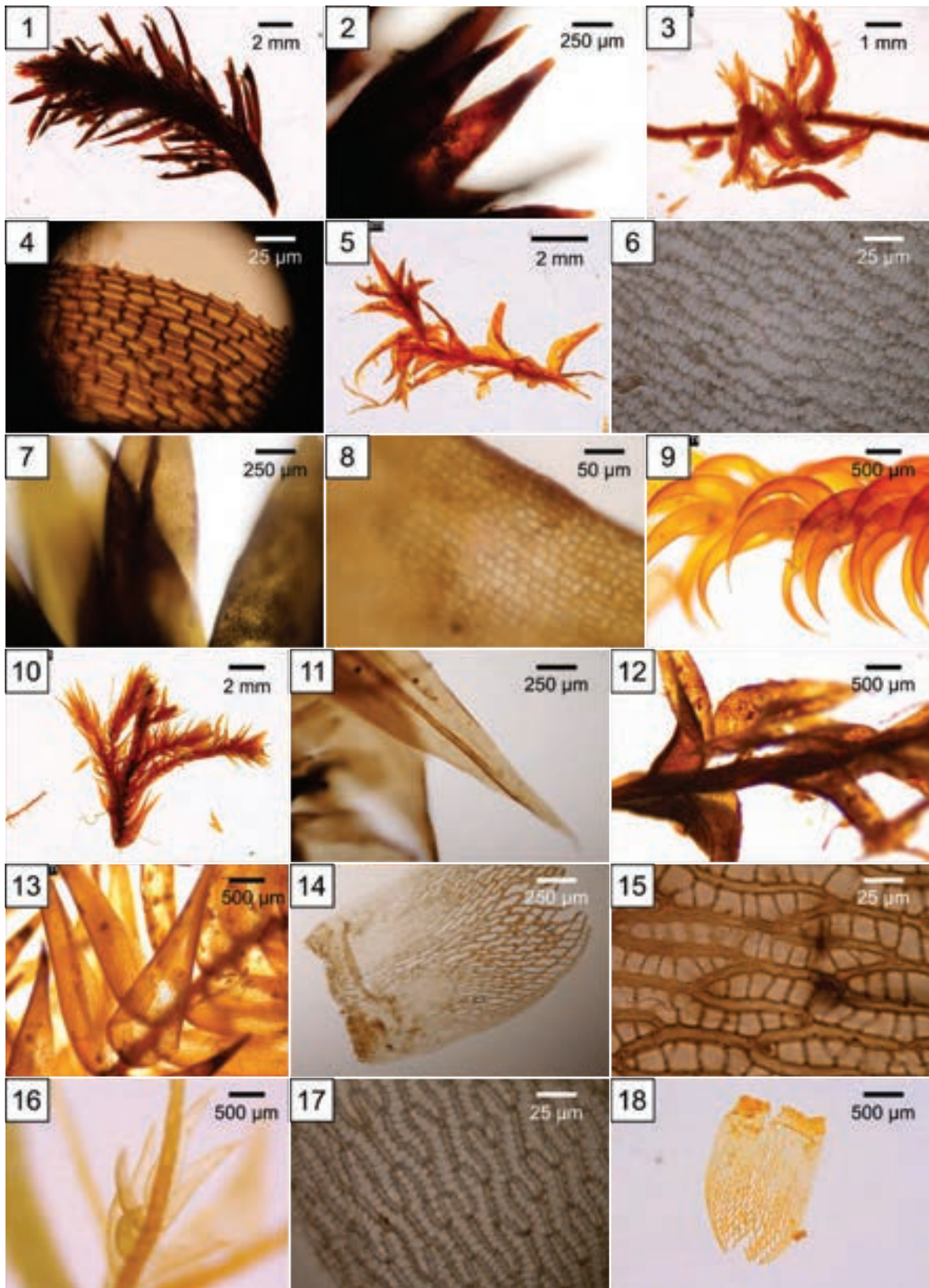

Figure 20: Representative plant macrofossils from each peat core/monolith that were selected for AMS  $^{14}\text{C}$  dating. 1) 16PS1 0 – 5 mm – *Dicranum?* sp.; 2) 16PS1 80 – 85 mm –

*Dicranum?* sp.; 3) 16PS2 55 – 60 mm — *Sphagnum* sect. *Acutifolia*; 4) 18-GTA-79 4 – 5cm – *Meesia triquetra*; 5) 18-GTA-79 4 – 5 cm — *Meesia triquetra*; 6) 16PS2 285 – 290 mm — leaf cells of *Sphagnum* sect. *Acutifolia*; 7) 18-GTA-79 12 – 13 cm — *Aulacomnium palustre*; 8) 18-GTA-79 12 – 13 cm — characteristic leaf cells of *Aulacomnium palustre*; 9) MAC S3 2E 0 – 1 cm — *Scorpidium* sp.; 10) 18-GTA-292 0 – 1 cm — *Tomentypnum nitens*; 11) 18-GTA-292 0 – 1cm — *Tomentypnum nitens*; 12) MAC S4 3E 1 – 2 cm — *Meesia triquetra*; 13) MAC S1 57E 55 – 56 cm — *Sphagnum lindbergii*; 14) MAC S1 57E 55 – 56 cm — stem leaf of *Sphagnum lindbergii*; 15) MAC S1 57E 55 – 56 cm — leaf cells of *Sphagnum lindbergii*; 16) MAC S3 2E 0 – 1 cm — *Sphagnum balticum*; 17) MAC S3 2E 0 – 1 cm — leaf cells of *Sphagnum balticum*; 18) MAC S3 8E 6 – 7 cm — stem leaf of *Sphagnum riparium*. Photo credits: Anne V. Nguyen, Carleton University, 2020.

**Table 7: Results from AMS  $^{14}\text{C}$  dating from the 14CHRONOS at Queen’s University, Belfast (QUB) and the AEL AMS laboratory at the University of Ottawa (AEL). Samples calibrated using OxCal v4.4 (Bronk Ramsey, 2009) and IntCal20.14C calibration curve (Reimer et al., 2020). The “E” designation for the MAC subsamples refers to the specific aliquot allocated for plant macrofossils.**

Sample ID	Plant macrofossils submitted	$^{14}\text{C}$ yrs BP	$^{14}\text{C}$ Age $\sigma$	Fraction modern, $F^{14}\text{C}$	$F^{14}\text{C}$ $\sigma$	Graphite (mg)	AD/BC	Depth (cm)	Notes
16PS1 0 – 5 mm	<i>Dicranum?</i>	Greater than modern		1.0591	0.0033	0.995		0	QUB
16PS1 40 – 45 mm	<i>Dicranum?</i> , <i>Brachythecium</i>	Greater than modern		1.0071	0.0031	0.664		4	QUB
16PS1 80 – 85 mm	<i>Dicranum?</i>	396	32	0.9518	0.0038	0.617	1486	8	QUB
16PS1 115 – 120 mm	<i>Dicranum?</i>	634	41	0.9241	0.0047	0.133	1346	11.5	QUB Small size
16PS1 120 – 125 mm	Barren for plant macrofossils								Not submitted
16PS1 160 – 165 mm	<i>Dicranum?</i> , <i>Sphagnum</i> sect. <i>acutifolia</i>	1779	55	0.8013	0.0055	0.126	289	16	QUB Small size
16PS1 200 – 205 mm	<i>Dicranum?</i> , <i>Sphagnum</i> sect. <i>acutifolia</i>	1798	38	0.7994	0.0038	0.383	269	20	QUB
16PS1 240 – 245 mm	<i>Dicranum?</i> , <i>Sphagnum</i> sect. <i>acutifolia</i>	Failed	Failed	Failed	Failed	Failed			QUB Failed
16PS1 245 – 250 mm	<i>Sphagnum</i> sect. <i>acutifolia</i>	2025	27	0.7772	0.0026	0.579		24.5	QUB
16PS1 280 – 285 mm	<i>Sphagnum</i> sect. <i>acutifolia</i>	2566	33	0.7266	0.003	0.945	-770	28	QUB
16PS1 300 – 305 mm	<i>Sphagnum</i> sect. <i>acutifolia</i>	2342	31	0.7471	0.0029	0.986	-403	30	QUB
16PS2 0 – 5 mm	Barren for plant macrofossils								Not submitted
16PS2 5 – 10 mm	Barren for plant macrofossils								Not submitted
16PS2 10 – 15 mm	<i>Sphagnum</i> sp.	Failed	Failed	Failed	Failed	Failed		1	Failed
16PS2 10 – 15 mm BULK*	Bulk organic material submitted	Greater than modern		1.0719	0.0041		1956 - 1957 (2.7%) 2002 - 2006 (92.8%)	1	AEL
16PS2 55 – 60 mm*	<i>Sphagnum</i> sect. <i>acutifolia</i>	278	26.76583	0.965996	0.003219		437 - 359 (51.2%) 331 - 286 (41.9%) 165 - 156 (2.3%)	5.5	AEL

16PS2 110 – 115 mm*	<i>Sphagnum</i> sect. <i>acutifolia</i>	272	27.85037	0.966751	0.003352		435 - 360 (43.1%) 330 - 283 (46.8%) 169 - 153 (5.6%)	11	AEL
16PS2 165 – 170 mm*	<i>Sphagnum</i> sect. <i>acutifolia</i>	478.802 8	25.62663	0.942137	0.003006		540 - 498 (95.4%)	16.5	AEL
16PS2 215 – 220 mm*	<i>Sphagnum</i> sect. <i>acutifolia</i>	923.466 7	26.96809	0.891403	0.002993		916 - 772 (92.1%) 759 - 746 (3.3%)	21.5	AEL
16PS2 220 – 225 mm	<i>Sphagnum</i> , <i>Picea</i> needles								Not submitted
16PS2 285 – 290 mm*	<i>Sphagnum</i> sect. <i>acutifolia</i>	1936.67 3	43.68733	0.785771	0.004273		1984 - 1964 (3.9%) 1945 - 1740 (91.6%)	28.5	AEL
18-GTA-79 0 – 1 cm	<i>Meesia triquetra</i> , <i>Bryum</i> ?	Greater than modern		1.1013	0.0038	0.276		0	QUB
18-GTA-79 4 – 5 cm	<i>Meesia triquetra</i>	301	45	0.9632	0.0054	0.136	1567	4	QUB Small size
18-GTA-79 8 – 9 cm	<i>Aulacomnium</i> <i>palustre</i> , <i>Tomentypnum</i> <i>nitens</i>	629	29	0.9246	0.0033	0.333	1350	8	QUB
18-GTA-79 12 – 13 cm	<i>Aulacomnium</i> <i>palustre</i> , <i>Tomentypnum</i> <i>nitens</i>	416	30	0.9495	0.0035	0.583	1465	12	QUB
18-GTA-292 0 – 1 cm	<i>Tomentypnum</i> <i>nitens</i>	Greater than modern		1.0418	0.0036	0.964		0	QUB
18-GTA-292 4 – 5 cm	<i>Tomentypnum</i> <i>nitens</i>	Greater than modern		1.0745	0.0032	1.002		4	QUB
18-GTA-292 7 – 8 cm	<i>Tomentypnum</i> <i>nitens</i>	Greater than modern		1.2819	0.0052		1959 (5.0%) calAD 1961 - 1962 (9.1%) calAD 1979 - 1980 (76.8%) calAD 1981 (4.6%) calAD	7	AEL
18-GTA-292 10 – 11 cm	<i>Tomentypnum</i> <i>nitens</i>	Greater than modern		1.3302	0.0035	0.96		10	QUB
18-GTA-292 14 – 15 cm	<i>Tomentypnum</i> <i>nitens</i>	214	27	0.9737	0.0032	0.995	1766	14	QUB
MAC S1 2E 0 – 1 cm	<i>Loeskypnum</i> <i>badium</i>	Greater than modern		1.0274	0.0021		1955-1956 (12.4%) 2012-2015 (83.1%) calAD	0	AEL
MAC S1 9E 7 – 8 cm	<i>Pseudocalliergon</i> <i>trifarium</i>	33	17	0.9958	0.0021		1702-1722 (27.1%) 1815-1835 (26.7%) 1890-1909 (41.7%) calAD†	7	AEL
MAC S1 17E 15 – 16 cm	<i>Pseudocalliergon</i> <i>trifarium</i> , <i>Scorpidium</i> <i>scorpioides</i>	214	17	0.9738	0.002		1648-1680 (36.7%) 1740-1753 (5.5%) 1762-1800 (50.9%) >1940 (2.4%) calAD†	15	AEL
MAC S1 25E 23 – 24 cm	<i>Sphagnum</i> <i>lindbergii</i>	417	18	0.9494	0.0021		1438-1487 (95.4%) calAD	23	AEL

MAC S1 33E 31 – 32 cm	<i>Sphagnum lindbergii</i>	890	18	0.8951	0.0020		1050-1080 (16.9%) 1152-1219 (78.6%) calAD	31	AEL
MAC S1 41E 39 – 40 cm	<i>Sphagnum lindbergii</i>	838	19	0.9009	0.0021		1174-1262 (95.4%) calAD	39	AEL
MAC S1 49E 47 – 48 cm	<i>Sphagnum lindbergii</i>	939	18	0.8896	0.0020		1038-1159 (95.4%) calAD	47	AEL
MAC S1 57E 55 – 56 cm	<i>Sphagnum lindbergii</i>	1041	26	0.8785	0.0029	0.986	1006	55	QUB
MAC S2 2E 0 – 1 cm	<i>Scorpidium cossonii</i>	Greater than modern		1.0348	0.0022		1955-1956 (23.1%) 2011-2013 (2.8%) calAD	0	AEL
MAC S2 13E 11 – 12 cm	<i>Scorpidium cossonii</i>	Greater than modern		1.1153	0.0023		1958 (5.7%) 1995-1997 (89.7%) calAD	11	AEL
MAC S2 23E 21 – 22 cm	Bulk organic material submitted	246	20	0.9699	0.0024		1531-1538 (1.0%) 1636-1670 (70.5%) 1779-1800 (24.0%) calAD†	21	AEL
MAC S2 34E 32 – 33 cm	Bulk organic material submitted	974	19	0.8858	0.0021		1024-1051 (29.9%) 1080-1154 (65.5%) calAD	32	AEL
MAC S2 45E 43 – 44 cm	<i>Warnstorfia exannulata</i>	2082	20	0.7717	0.0019		166-42 (95.4%) calBC	43	AEL
MAC S2 56E 54 – 55 cm	Bulk organic material submitted	2420	20	0.7399	0.0019		730-700 (6.8%) 664-650 (3.8%) 546-406 (84.9%) calBC	54	AEL
MAC S2 67E 65 – 66 cm	Bulk organic material submitted	2455	20	0.7366	0.0019		753-682 (33.0%) 669-631 (14.0%) 625-610 (2.2%) 593-455 (41.3%) 445-417 (5.0%) calBC	65	AEL
MAC S2 79E 77 – 78 cm	<i>Sphagnum sect. acutifolia</i>	4985	32	0.5376	0.0022	0.667	-3751	77	QUB
MAC S3 2E 0 – 1 cm	<i>Sphagnum balticum</i>	Greater than modern		1.0458	0.0032	0.214		0	QUB
MAC S3 8E 6 – 7 cm	<i>Sphagnum balticum</i>	Greater than modern		1.1023	0.0038	0.96		6	QUB
MAC S3 17E 15 – 16 cm	Barren for plant macrofossils								Not submitted
MAC S3 18E 16 – 17 cm	Barren for plant macrofossils								Not submitted
MAC S3 19E 17 – 18 cm	Barren for plant macrofossils								Not submitted
MAC S3 20E 18 – 19 cm	<i>Sphagnum fuscum</i>	351	26	0.9572	0.0031	1.01	1559	18	
MAC S3 28E 26 – 27 cm	Barren for plant macrofossils								Not submitted
MAC S3 29E 27 – 28 cm	<i>Sphagnum fuscum</i>	962	37	0.8871	0.0041	0.267	1097	27	QUB
MAC S3 38E 36 – 37 cm	<i>Sphagnum fuscum</i>	1189	29	0.8624	0.0031	0.979	841	36	QUB
MAC S3 45E 43 – 44 cm	<i>Sphagnum fuscum</i>	Failed	Failed	Failed	Failed	Failed	Failed		QUB Failed
MAC S3 48E 46 – 47 cm	<i>Sphagnum sect. acutifolia</i>	Failed	Failed	Failed	Failed	Failed	Failed	46	QUB Failed
MAC S3 51E 49 – 50 cm	<i>Sphagnum sect. acutifolia</i> , <i>Sphagnum sect. cuspidata</i>	2017	33	0.778	0.0032	0.09			QUB

MAC S3 52E 50 – 51 cm	<i>Sphagnum</i> sect. <i>acutifolia</i>	Failed	Failed	Failed	Failed	Failed		50	Failed
MAC S3 58E 56 – 57 cm	<i>Sphagnum</i> sect. <i>cuspidata</i>	3530	45	0.6444	0.0036	0.207	-1849	56	QUB
MAC S3 68E 66 – 67 cm	<i>Sphagnum</i> sect. <i>cuspidata</i>	3848	32	0.6194	0.0025	0.619	-2316	66	QUB
MAC S3 78E 76 – 77 cm	<i>Sphagnum</i> <i>lindbergii</i>	4993	41	0.5371	0.0027	0.99	-3768	76	QUB
MAC S4 3E 1 – 2 cm	<i>Meesia triquetra</i> , <i>Drepanocladus</i> <i>sendtneri</i>	Greater than modern		1.1589	0.0025		1958 (20.2%) 1989-1990 (75.3%) calAD	1	AEL
MAC S4 13E 11 – 12 cm	Bulk organic material submitted	164	18	0.9798	0.0021		1666-1695 (17.1%) 1724-1784 (41.0%) 1795-1813 (10.0%) 1838-1878 (5.5%) >1915 (21.8%) calAD†	11	AEL
MAC S4 23E 21 – 22 cm	<i>Warnstorfia/Scorpi</i> <i>dium</i> cf. <i>cossonii</i> , <i>Campylium</i>	353	18	0.9570	0.0022		1470-1527 (42.4%) 1553-1634 (53.1%) calAD	21	AEL
MAC S4 33E 31 – 32 cm	<i>Scorpidium</i> cf. <i>cossonii</i> , <i>Calliergon</i> <i>richardsonii</i>	352	19	0.9571	0.0022		1470-1528 (41.8%) 1552-1634 (53.7%) calAD	31	AEL
MAC S4 43E 41 – 42 cm	Bulk organic material submitted	1486	20	0.8311	0.0021		551-611 (82.6%) 617-640 (12.9%) calAD	41	AEL
MAC S4 53E 51 – 52 cm	Bulk organic material submitted	1796	20	0.7997	0.0020		215-259 (42.8%) 281-329 (52.7%) calAD	51	AEL
MAC S4 60E 58 – 59 cm	Bulk organic material submitted	711	27	0.9153	0.0031	0.9	1285	58	QUB
MAC S4 61E 59 – 60 cm	Barren for plant macrofossils								Not submitted
MAC S4 62E 60 – 61 cm	Barren for plant macrofossils								Not submitted
MAC S4 63E 61 – 62 cm	Barren for plant macrofossils								Not submitted

\* Calibrated years before present (BP)

Age-depth profiles generated using ‘classical’ age-depth modelling (CLAM; Blaauw, 2010) all show general increasing age with increased depth (Fig. 21a, b). CLAM uses linear interpolation and smooth splines to model age-depth curves and is applied prior to generating Bayesian age-depth models (i.e., Bayesian accumulation (Bacon)), the latter of which requires known *a priori* input, such as sediment accumulation rate (Blaauw and Christen, 2011).

Age-depth profiles are most consistent with MAC S3 whereas all other age-depth profiles have one age reversal each, although most of these are within the expected range of error, with the exception of MAC S4. Peat monolith 18-GTA-292 returned mostly “greater than modern” values, with the exception of its basal sub-sample.

The youngest peat cores are 18-GTA-292 with a basal age of  $214 \pm 27$  calibrated years before present (yr BP) and 18-GTA-79 at  $416 \pm 30$  yr BP. The 16PS cores have a basal age range between  $1937 \pm 44$  (16PS2) and  $2342 \pm 31$  (16PS1) yr BP. The basal ages for the MAC cores range between 711 and 4993 yr BP. The basal sub-sample in MAC S4 records the youngest age of the peat profiles at  $711 \pm 27$  yr BP, although the oldest recorded date in MAC S4 is  $1796 \pm 20$  yr BP at a depth of 51 cm (Fig. 21b). MAC S3 yields the oldest date at  $4993 \pm 41$  yr BP.



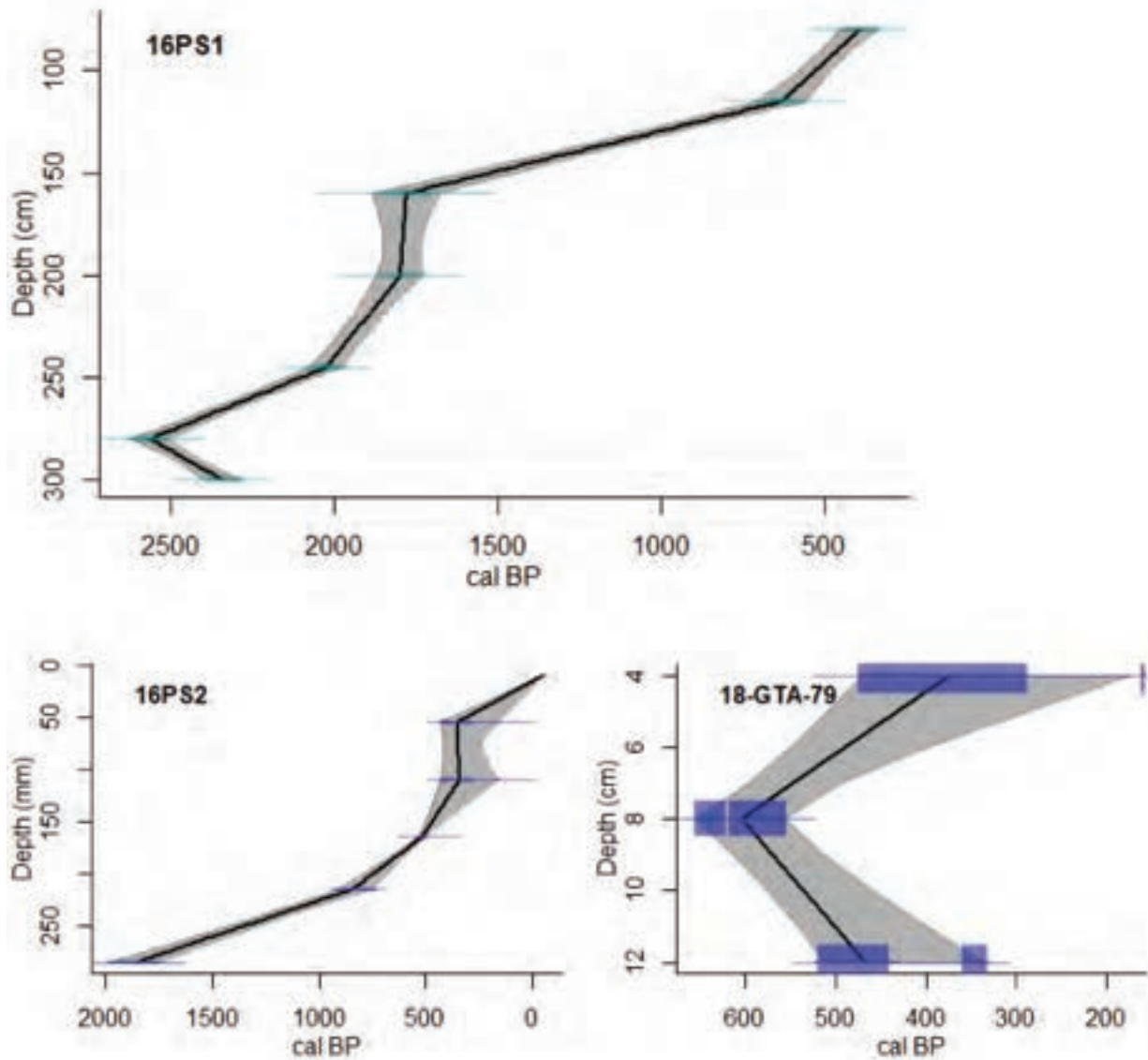

**Figure 21a:** Age depth models calibrated to cal BP using the IntCal20.14C curve (Reimer et al., 2020) from CLAM (Blaauw, 2010) for peat monoliths 16PS1, 16PS2, 18-GTA-79. Radiocarbon dates for 18-GTA-292 are mostly greater than modern, with the exception of its basal date.

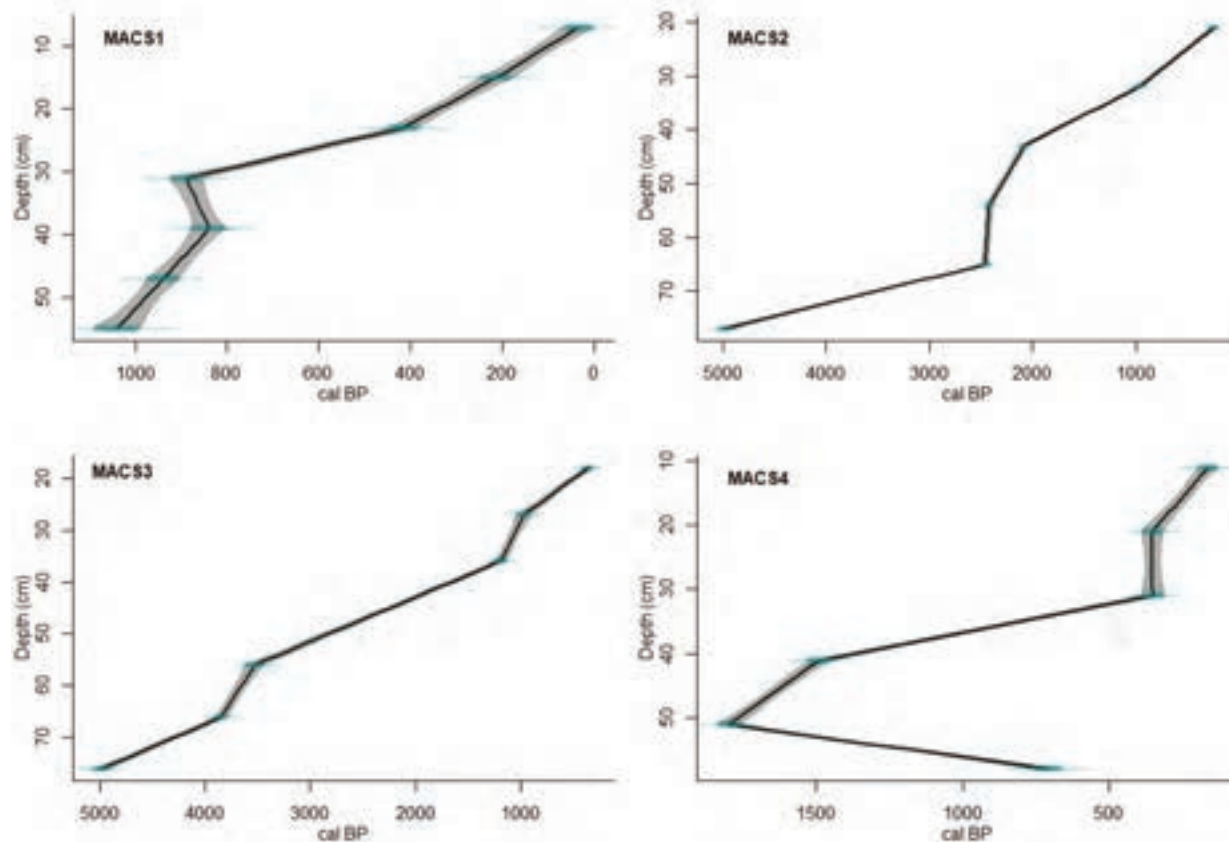
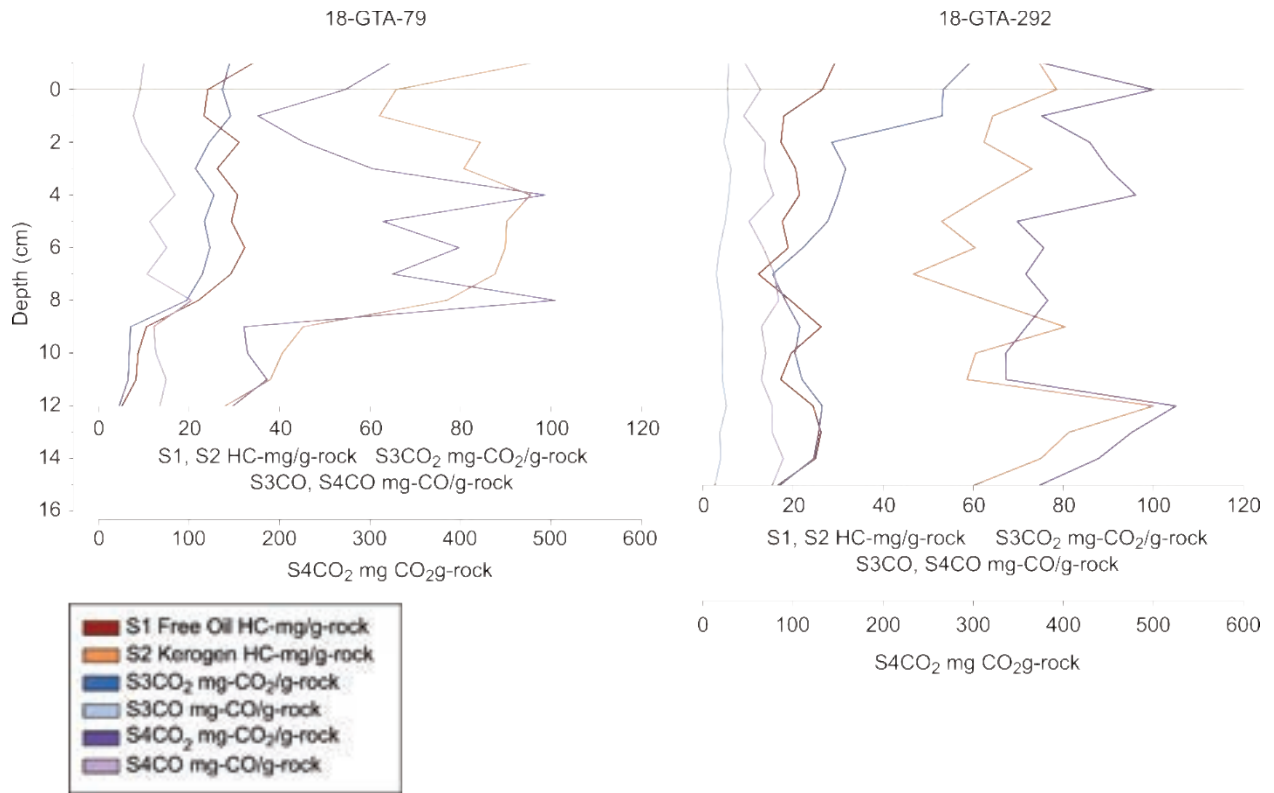

**Figure 21b: Age depth models calibrated to cal BP using the IntCal20.14C curve (Reimer et al., 2020) from CLAM (Blaauw, 2010).**

### HAWK Pyrolysis

Results for HAWK pyrolysis are available for peat monoliths/cores 18-GTA-79, -292 (Fig. 22a) and MAC S1 – 4 (Fig. 22b; Polar Data Catalogue CCIN 13261; see also Appendix A). In HAWK pyrolysis, the components of the S1 fraction are dominated by lipids and sucrose, with minor amounts of cellulose and carbohydrates that characterize some plant materials (Carrie et al., 2012). The S2 fraction is also dominated by lipids, specifically cell wall lipids that are derived from algae, with minor contributions from plant materials. The S3 fraction, split into S3CO and S3CO<sub>2</sub>, comprises carbohydrates, lignins, and plant standards. Residual carbon, or the S4 fraction, comprises terrigenous plant materials that contain cellulose and lignin.

In 18-GTA-79, S1 to S4 carbon fractions all increase dramatically upwards of 10 cm depth, suggesting an increase in the preservation of organic matter at shallower depths. This trend is also reflected in MAC S4 above 47 cm depth. In 18-GTA-292, S1 – 4 carbon fractions all spike at 12 cm depth, which may indicate higher organic matter production and/or preservation at this interval.



**Figure 22a: HAWK pyrolysis results for S1, S2, S3, S4 carbon for peat monoliths 18-GTA-79 (left), 18-GTA-292 (right).**

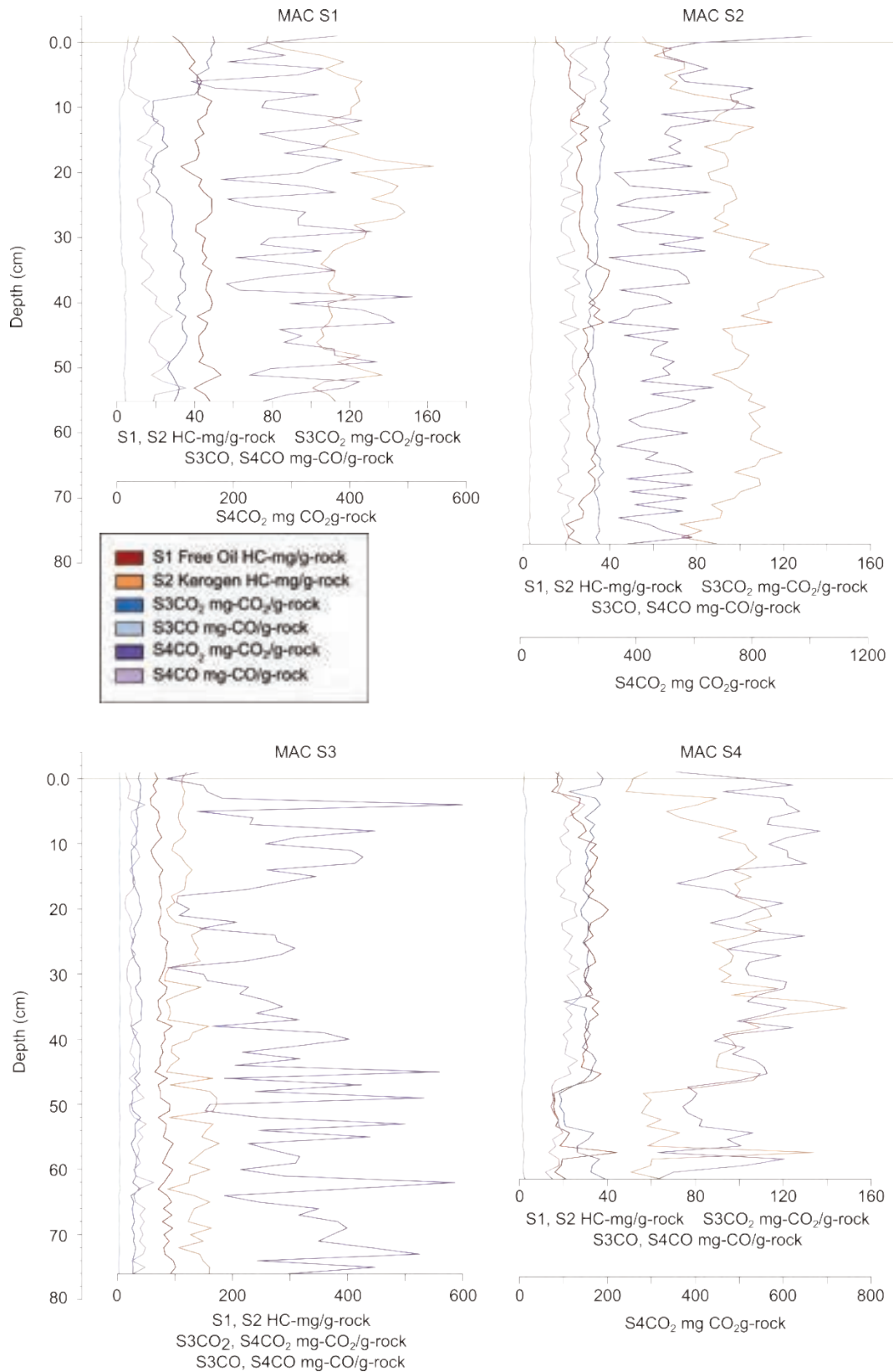

**Figure 22b: HAWK pyrolysis results S1, S2, S3, S4 carbon for cores MAC S1-4 (Appendix A; Polar Data Catalogue CCIN 13261).**

## DISCUSSION

### Radiometric Dates

The age reversals may be a result from repeated drying/wetting cycles within the peat profile, which results in younger peat layers modifying/superimposing on older peat layers (i.e., secondary decomposition) (Biester et al., 2007; Steinmann et al., 2006). This is especially evident in those peat monoliths that were not frozen immediately upon collection. MAC S3 was the only peat core that did not have an age reversal in the age-depth profiles, whereas all other peat cores had at least one. This may also be due to MAC S3 being the only ombrotrophic bog (pH < 4) and therefore being the least likely to have been affected by external sources of water.

### HAWK Pyrolysis

HAWK pyrolysis determines different groups of organic compounds (i.e., labile and refractory organic matter) based on the different temperatures during pyrolysis (Tissot and Welte, 1978). The S2 peak in particular represents the amount of hydrocarbons generated during organic matter degradation at 550°C (Biester et al., 2014). When normalized to TOC content, this amount is defined as the Hydrogen Index (HI). Normalizing the S3 CO<sub>2</sub> peak to TOC content gives the Oxygen Index (OI) (Lafargue et al., 1998). The OI is expected to be high in peat layers with low decomposition and higher amounts of compounds containing oxygen, like polysaccharides (e.g., cellulose). Low rates of peat decomposition are generally correlated with wetter conditions or higher water table depth; conversely, when peat decomposition is high, drier conditions are expected, and/or water table depth is low (Clymo, 1984). High values for the OI have been shown to be correlated with *Sphagnum*-dominated sections, whereas high values for the HI is correlated with enrichment of aliphatic structures in general, which is predominantly caused by decomposition and not vegetation change (Biester et al., 2014).

In MAC S1, 18-GTA-79, 18-GTA-292, high OI values (reflected as S3) are observed near the top of the peat profile (Fig. 23a, b), suggesting low decomposition and higher amounts of possible cellulose. This is consistent with their relatively younger age in comparison to the other peat cores/monoliths and implies wetter conditions or a higher water table depth. The HI values for these peat profiles tend to be consistent within a range.

In MAC S2, the HI values have a lower range at the top of the peat profile, with relatively consistent OI values, suggesting increasing decomposition with depth. At surface level, low HI values suggest low decomposition and therefore higher water table depth or wetter conditions.

In MAC S3, the OI values tend to broadly follow the occurrence of different types of identified *Sphagnum* moss. At the top of this peat profile, both OI and HI values are relatively high, suggesting high peat decomposition and relatively drier conditions or a lower water table.

In MAC S4, HI values are at a minimum at the top of the peat profile, suggesting low decomposition and wetter conditions. This is supported by concurrent high values of OI. Most prominent in the MAC S4 peat profile is the spike in HI values near the bottom and relatively low OI values, suggesting a brief period of high decomposition and therefore drier conditions.

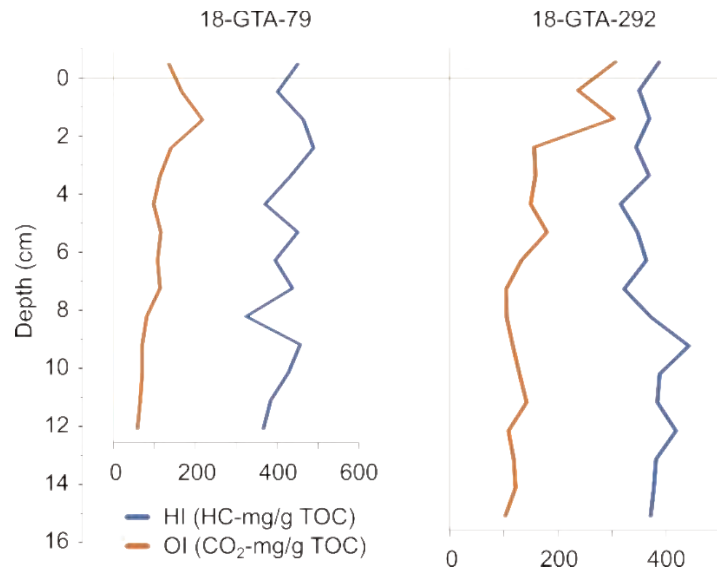

**Figure 23a: Hydrogen Index (HI) and Oxygen Index (OI) values for GTA peat profiles.**

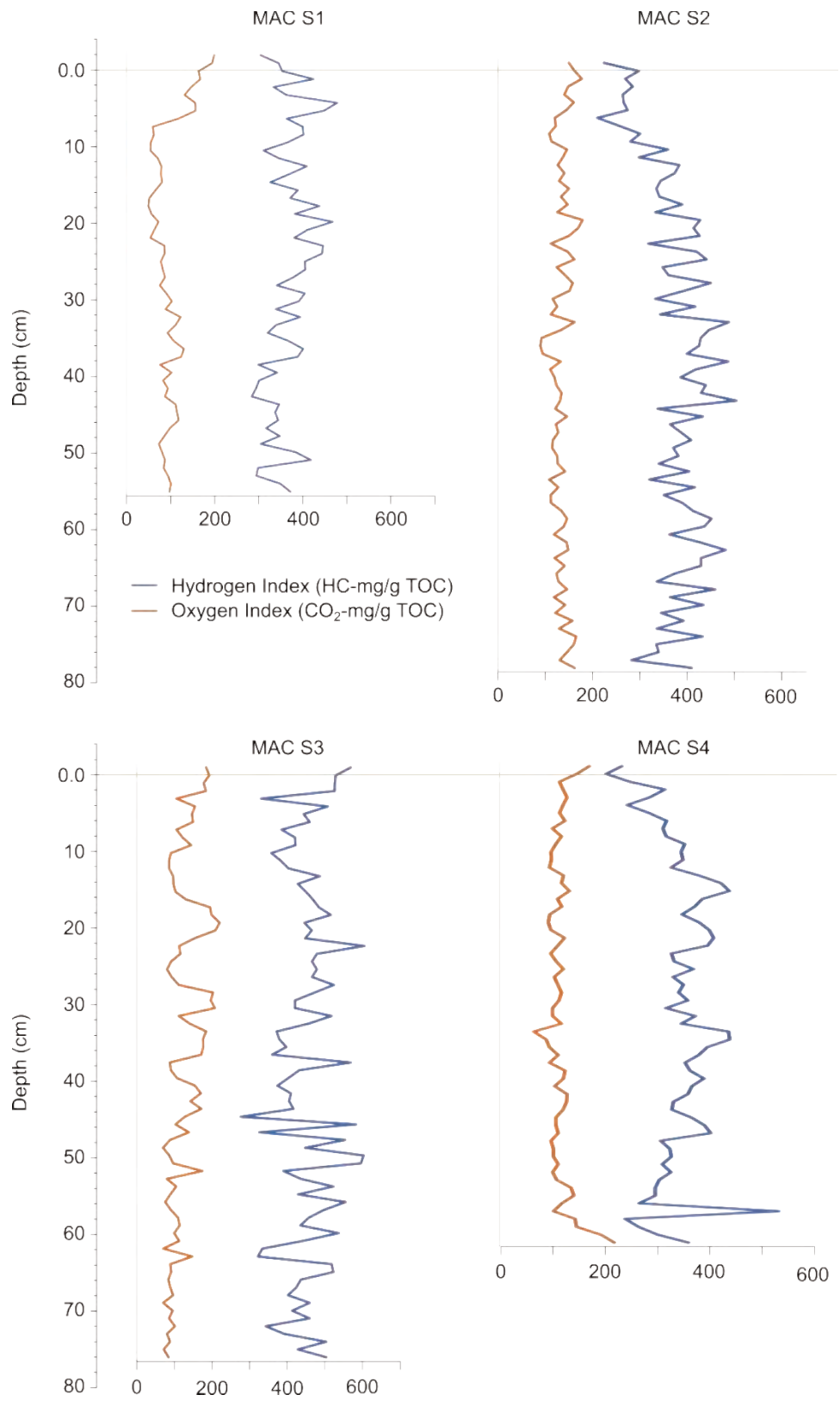

**Figure 23b: Hydrogen Index and Oxygen Index values for MAC peat profiles.**

## CONCLUSIONS (Plain language; English)

This report summarizes results so far for the project called “Long-term hydrological dynamics of the Mackenzie River Basin”. Four peat cores (called 16PS1, 16PS2, 18-GTA-292, 18-GTA-79, MAC S1, MAC S2, MAC S3, MAC 24) collected from peatlands in and around the Gwich’in Settlement Area were studied for microscopic fossils, metals, the type and amount of organic matter, and the remains of plants and charcoal to reconstruct how climate has changed over the past hundreds to thousands of years, and how vegetation, fires, and water levels have changed as a result. The cores are dated to determine how they are. The bottom of the oldest core is 4993 years old, while the bottom of the youngest core is 214 years old. Most of the peat cores show that wetter conditions or higher water levels occurred in more recent years compared to hundreds to thousands of years ago. All data reported in this open file is included in the Polar Data Catalogue CCIN 13261.

## GUK’IIGHÈ’ JÙU DIGWIINIINDHANH

Nagwichoonyik gwa’àn chuu dagwiheech’aa geenjit gik’itr’aanjii jii dinehtl’eh zhìt geenjit diiyah tr’igwaandak. Gwich’in Nanhkak gwa’àn nìn’ nihlinehch’i’ daankat gwizhìt gugwinah’in’ (jii gwinjik guutr’oozrih 16PS1, 16PS2, 18-GTA-292, 18-GTA-79, MAC S1, MAC S2, MAC S3, MAC 24) ejiich’ii nihlinehch’i’ jii nìn’ zhìt goo’aii geenjit gik’igaaanjii k’iighè’ yi’eenoo gwiinlit nagwidadhat guuzhik nan ejuk t’igwinjii k’iighè’ gwinzhìh, kwàn’ ts’at chuu dagwahleii gwiinli’ ejuk goonlii gik’igaaanjih. Nìn’ dahthee ezhik tiinch’u’ gik’igaaanjik k’iighè’ nits’òo diinch’uu gahgwidandaih. Nìn’ gwiteh goo’aii gwilàt nagwidadhat 4993 ezhik goo’aii ts’at gwilàt nagwidadhat 214 ezhik goo’aih. Jùk gweendoo gwiiyeendoo nan gwiltraa ts’at yi’eenoo dàì’ gwiiyeendoo nan gwiltrah kwaa k’it jii nìn’ gugwideech’inh. Jii gwizhìt diiyah tr’igwaandak Polar Data Catalogue CCIN 13261chan gwizhìt diinch’uh.



## REFERENCES

- Abdul Aziz, O.I. & Burn, D.H. 2006. Trends and variability in the hydrological regime of the Mackenzie River Basin. *Journal of Hydrology* 319, 282-294.
- Alewell, C., Giesler, R., Klaminder, J., Leifeld, J., & Rollog, M. 2011. Stable carbon isotopes as indicators for environmental change in peatlands. *Biogeosciences* 8, 1769-1778.
- Amesbury, M.J., Booth, R.K., Roland, T.P., et al. 2018. Towards a Holarctic synthesis of peatland testate amoeba ecology: Development of a new continental-scale palaeohydrological transfer function for North America and comparison to European data. *Quaternary Science Reviews* 201, 483-500.
- Appleby, P.G. 1998. Dating recent sediment by  $^{210}\text{Pb}$ : Problems and solutions. In: *Proceedings of a Seminar, Helsinki, 2-3 April, 1997*. STUK-A 145. pp. 7-24.
- Appleby, P.G. & Oldfield, F. 1978. The calculation of lead-210 dates assuming a constant rate of supply of unsupported  $^{210}\text{Pb}$  to the sediment. *Catena* 5, 1-8.
- Appleby, P.G., Nolan, P.J., Oldfield, F., Richardson, N., & Higgitt, S.R. 1988.  $^{210}\text{Pb}$  dating of lake sediments and ombrotrophic peats by gamma assay. *The Science of the Total Environment* 69, 157-177.
- Barber, K.E. 1982. Peat-bog stratigraphy as a proxy climate records. In: *Climatic Change in Later Prehistory* (ed. A.F. Harding). Edinburgh University Press, Edinburgh, 103-133.
- Barber, K.E. 1985. Peat stratigraphy and climatic changes: some speculations. In: *The Climatic Scene: Essays in Honour of Gordon Manly* (eds. M.J. Tooley and G.M. Sheail). Allen and Unwin, London, 175-185
- Barkay, T., Kroer, N., & Poulain A.J. 2011. Some like it cold: microbial transformations of mercury in polar regions. *Polar Research* 30, 154-69.
- Batjes, N.H. 1996. Total carbon and nitrogen in the soils of the world. *European Journal of Soil Science* 47, 151-163.
- Beilman, D.W., Vitt, D.H., Bhatti, J.S., & Forests, S. 2008. Peat carbon stocks in the southern Mackenzie River Basin: uncertainties revealed in a high-resolution case study. *Global Change Biology* 14, 1-12.
- Bhatt, U.S., Walker, D.A., Raynolds, M.K., et al. 2010. Circumpolar Arctic Tundra Vegetation Change Is Linked to Sea Ice Decline. *Earth Interactions* 14(8), 1-20.
- Biester, H., Bindler, R., Martinez-Cortizas, A., & Engstrom, D.R. 2007. Modeling the past atmospheric deposition of mercury using natural archives. *Environmental Science & Technology* 41, 4851-4860.

- Biester, H., Knorr, K.-H., Schellekens, J., Basler, A., & Hermans, Y.-M. 2014. Comparison of different methods to determine the degree of peat decomposition in peat bogs. *Biogeosciences* 11, 2691-2707.
- Blaauw, M. 2010. Methods and code for 'classical' age-modelling of radiocarbon sequences. *Quaternary Geochronology* 5, 512-518.
- Blaauw, M. & Christen, J.A. 2011. Flexible paleoclimate age-depth models using an autoregressive gamma process. *Bayesian Analysis* 6, 457-474.
- Booth, R.K. 2008. Testate amoebae as proxies for mean annual water-table depth in *Sphagnum* dominated peatlands of North America. *Journal of Quaternary Science* 23, 43-57.
- Booth, R.K., Lamentowicz, M., & Charman, D.J. 2010-11. Preparation and analysis of testate amoebae in peatland palaeoenvironmental studies. *Mires and Peat* 7(2), 1-7.
- Bronk Ramsey, C. 2009. Bayesian Analysis of Radiocarbon Dates. *Radiocarbon* 51(1), 337-360.
- Brunskill, G.J. 1986. Environmental features of the Mackenzie system. In: *The Ecology of River Systems* (eds. B.R. Walker and K.F. Davies). Dr W. Junk Publishers, Dordrecht, The Netherlands, 435-472.
- Carrie, J., Sanei, H., & Stern, G. 2012. Standardisation of Rock-Eval pyrolysis for the analysis of recent sediments and soils. *Organic Geochemistry* 46, 38-53.
- Caruso, J.A., & Montes-Bayon, M. 2003. Elemental speciation studies – new directions for trace metal analysis. *Ecotoxicology and Environmental Safety* 56(1), 148-163.
- Charman, D.J. 2001. Biostratigraphic and palaeoenvironmental applications of testate amoebae. *Quaternary Science* 20 (16-17), 1753-1764.
- Charman, D.J. & Warner, B.G. 1992. Relationship between testate amoebae (Protozoa: Rhizopoda) and microenvironmental parameters on a forested peatland in northeastern Ontario. *Canadian Journal of Zoology* 70, 2474-2482.
- Clymo, R.S. 1984. The limits to peat bog growth. *Philosophical Transactions of the Royal Society B, Biological Sciences* 303, 605–654.
- De Vleeschouwer, F. & Shotyck, W. 2010. Peat as an archive of atmospheric pollution and environmental change: a case study of lead in Europe. *PAGES magazine* 18(1), 20-22.
- De Vleeschouwer, F., Chambers, F.M., & Swindles, G.T. 2010. Coring and sub-sampling of peatlands for paleoenvironmental research. *Mires and Peat* 7(1), 1-10.

Dorrepaal, E., Toet, S., van Lotestijn, R.S.P., Swart, E., van de Weg, M.J., Callaghan, T.V., & Aerts, R. 2009. Carbon respiration from subsurface peat accelerated by climate warming in the subarctic. *Nature* 460, 616-619.

Environment Canada & Wilcox, D.A. 2002. *Where Land Meets Water: Understanding Wetlands of the Great Lakes*. Government Documents 37, 72 pages.

Fahnestock, M.F., Bryce, J.G., McCalley, C.K., Montesdeoca, M., Bai, S., Li, Y., Driscoll, C.T., Crill, P.M., Rich, V.I., & Varner, R.K. 2019. Mercury reallocation in thawing subarctic peatlands. *Geochemical Perspectives Letters* II, 33-38.

Gałka, M., Tanțău, I., & Feurdean, A. 2017a. Plant succession in a peatland in the Eastern Carpathian Mts. (CE Europe) during the last 10,200 years: Implications for peatland development and palaeoclimatic research. *Review of Palaeobotany and Palynology* 244, 203-216.

Gałka, M., Tobolski, K., Lamentowicz, Ł. Ersek, V., Jasse, V.E.J., van der Knaap, W., & Lamentowicz, M. 2017b. Unveiling exceptional Baltic bog ecohydrology, autogenic succession and climate change during the last 2000 years in CE Europe using replicate cores, multi-proxy data and functional traits of testate amoebae. *Quaternary Science Reviews* 156, 90-106.

Gałka, M., Galloway, J.M., Lemonis, N., Mazei, Y., Mitchell, E., Morse, P.D., Patterson, R.T., Tsyganov, A., Wolfe, S., & Swindles, G.T. 2018. Palaeoecology of *Sphagnum riparium* (Ångström) in Northern Hemisphere peatlands: implications for peatland conservation and palaeoecological research. *Review of Palaeobotany and Palynology* 254, 1-7.

Givelet, N., Le Roux, G., Cheburkin, A., et al. 2004. Suggested protocol for collecting, handling and preparing peat cores and peat samples for physical, chemical, mineralogical and isotopic analyses. *Journal of Environmental Monitoring* 6(5), 481-492.

Gorham, E. 1991. Northern Peatlands: Role in the Carbon Cycle and Probable Responses to Climatic Warming. *Ecological Applications* 1(2), 182-195.

Huntley, B. 1990. Studying global change: the contribution of Quaternary palynology. *Palaeogeography, Palaeoclimatology, Palaeoecology (Global and Planetary Change Section)* 82, 53-61.

Joosten, H. 2015. Peatlands, climate change mitigation and biodiversity conservation: An issue brief on the importance of peatlands for carbon and biodiversity conservation and the role of drained peatlands as greenhouse gas emission hotspots. *Nordic Council of Ministers* Vol. 2015727.

Krachler, M. & Shotyk, W. 2004. Natural and anthropogenic enrichments of molybdenum, thorium, and uranium in a complete peat bog profile, Jura Mountains, Switzerland. *Journal of Environmental Monitoring* 6, 418-426.

- Krachler, M., Mohl, C., Emons, H., & Shotyk, W. 2002. Influence of digestion procedures on the determination of rare earth elements in peat and plant samples by USN-ICP-MS. *Journal of Analytical Atomic Spectrometry* 17, 844-851.
- Krachler, M., Mohl, C., Emons, H., & Shotyk, W. 2003. Two thousand years of atmospheric rare earth element (REE) deposition as revealed by an ombrotrophic peat bog profile, Jura Mountains, Switzerland. *Journal of Environmental Monitoring* 5, 111-121.
- Lafargue, E., Marquis, F., & Pillot, D. 1998. Rock-Eval 6 applications in hydrocarbon exploration, production, and soil contamination studies. *Revue de l'Institut Français du Pétrole* 53, 421-437.
- Larsen, J.A. 1982. *Ecology of the northern lowland bogs and conifer forests*. New York, NY: Academic Press.
- Lawrence, D.M., Slater, A.G., Tomas, R., Holland, M.M., & Deser, C. 2008. Accelerated Arctic land warming and permafrost degradation during rapid sea ice loss. *Geophysical Research Letters* 35, L11506.
- Lehnherr, I., St. Louis, V.L., Emmerton, C.A., Barker, J.D., & Kirk, J.L. 2012. Methylmercury Cycling in High Arctic Wetland Ponds: Sources and Sinks. *Environmental Science & Technology* 46, 10514-10422.
- Leifeld, J. & Menichetti, L. 2018. The underappreciated potential of peatlands in global climate change mitigation strategies. *Nature Communications* 9(1), 1071.
- Leroyer, C., Joannin, S., Aoustin, D., Ali, A.A., Peyron, O., Ollivier, V., Tozalakyan, P., Karakhanyan, A., & Jude, F. 2015. Mid Holocene vegetation reconstruction from Vanevan peat (south-eastern shore of Lake Sevan, Armenia). *Quaternary International* 395, 5-18.
- Manabe, S. & Stouffer, R.J. 1980. Sensitivity of a global climate model to an increase of CO<sub>2</sub> in the atmosphere. *Journal of Geophysical Research* 85 (C10), 5529-5554.
- Markel, E., Booth, R.K., & Qin, Y. 2010. Testate amoebae and  $\delta^{13}\text{C}$  of *Sphagnum* as surface-moisture proxies in Alaskan peatlands. *The Holocene* 20, 463-475.
- Mauquoy, D. & van Geel, B. 2007. Plant macrofossil methods and studies: Mire and Peat Macros. In: *Encyclopedia of Quaternary Science* vol. 3 (ed. S.A. Elias). Elsevier, Amsterdam, The Netherlands, 2315-2336.
- Mergler, D., Anderson, H.A., Hing Man Chan, L., Mahaffey, K.R., Murray, M., Sadamoto, M., & Stern, H. 2007. Methylmercury exposure and health effects in humans: a worldwide concern. *Ambio* 36, 3-11.

- Miller, G.H., Alley, R.B., Brigham-Grette, J., Fitzpatrick, J.J., Polyack, L., Serreze, M.C., & White, J.W.C. 2010. Arctic amplification: can the past constrain the future? *Quaternary Science Reviews* 29 (15-16), 1779-1790.
- Mitchell, E., Charman, D., & Warner, B. 2008. Testate amoebae analysis in ecological and paleoecological studies of wetlands: past, present and future. *Biodiversity and Conservation* 17, 2115-2137.
- Mitchell, E.A.D., Payne, R.J., van der Knaap, W., Lamentowicz, Ł., Gąbka, M., & Lamentowicz, M. 2013. The performance of single- and multi-proxy transfer functions (testate amoebae, bryophytes, vascular plants) for reconstructing mire surface wetness and pH. *Quaternary Research* 79, 6-13
- Moldovan, M., Krupp, E.M., Holliday, A.E., & Donard, O.F.X. 2004. High resolution sector field ICP-MS and multicollector ICP-MS as tools for trace metal speciation in environmental studies: a review. *Journal of Analytical Atomic Spectrometry* 19, 815-822
- Morel, F.M.M., Krepiel, A.M.L., & Amyot, M. 1998. The chemical cycle and bioaccumulation of mercury. *Annual Review of Ecology, Evolution, and Systematics* 29, 543-566.
- Oksanen, J., Blanchet, F., Kindt, R., Legendre, P., O'Hara, R.B., Simpson, G., Solymos, P., Stevens, M. & Wagner, H. 2015. Multivariate analysis of ecological communities. *Vegan Tutorial*, 1-40.
- Overland, J.E. & Wang, M. 2010. Large-scale atmospheric circulation changes are associated with the recent loss of Arctic sea ice. *Tellus A: Dynamic Meteorology and Oceanography* 62(1), 1-9.
- Payne, R.J. & Mitchell, E.A.D. 2009. How many is enough? Determining optimal count totals for ecological and palaeoecological studies of testate amoebae. *Journal of Paleolimnology* 42, 483-495.
- Piotrowska, N., Blaauw, M., Mauquoy, D., & Chambers, F.M. 2011. Constructing deposition chronologies for peat deposits using radiocarbon dating. *Mires and Peat* 7(10), 1-14.
- Poto, L., Gabrieli, J., Crowhurst, S., Agostinelli, C., Spolaor, A., Cairns, W.R.L., Cozzi, G., & Barbante, C. 2015. Cross calibration between XRF and ICP-MS for high spatial resolution analysis of ombrotrophic peat cores for palaeoclimatic studies. *Analytical and Bioanalytical Chemistry* 407, 379-385.
- Reimer, P.J., Austin, W.E.N., Bard, E., et al. 2020. The IntCal20 Northern Hemisphere Radiocarbon Age Calibration Curve (0-55 cal kBP). *Radiocarbon* 62(4), 725-757.
- Rosenberg, D.M. & Barton, D.R. 1986. The Mackenzie River System. In: *The Ecology of River Systems* (eds. Walker and Davies). Dr W. Junk Publishers, Dordrecht, The Netherlands, 425-434.

- Rozema, J., Boelen, P., Doorenbosch, M., Bohncke, S., Blokker, P., Boekel, C., Broekman, R.A., & Konert, M. 2006. A vegetation, climate and environment reconstruction based on palynological analyses of high arctic tundra peat cores (5000-6000 years BP) from Svalbard. *Plant Ecology* 182, 155-173.
- Sanei, H., Stasiuk, L.D., & Goodarzi, F. 2005. Petrological changes occurring in organic matter from Recent lacustrine sediments during thermal alteration by Rock-Eval™ pyrolysis. *Organic Geochemistry* 36(8), 1190-1203.
- Schönborn, W. 1992. Adaptive polymorphism in soil-inhabiting testate amoebas (Rhizopoda)—its importance for delimitation and evolution of asexual species. *Archiv für Protistenkunde* 142, 139-155.
- Schuur, A.E.G., Vogel, J.G., Crummer, K.G., Lee, H., Sickman, J.O., & Osterkamp, T.E. 2009. The effect of permafrost thaw on old carbon release and net carbon exchange from tundra. *Nature* 459, 556-559.
- Sebag, D., Disnar, J.R., Guillet, B., Di Giovanni, C., Verracchia, E.P., & Durand, A. 2006. Monitoring organic matter dynamics in soil profiles by ‘Rock-Eval pyrolysis’: bulk characterization and quantification of degradation. *European Journal of Soil Science* 57(3), 344-355.
- Serreze, M.C. & Barry, R.G. 2011. Processes and impacts of Arctic amplification: A research synthesis. *Global and Planetary Change* 77, 85-96.
- Shotyk, W. 2002. The chronology of anthropogenic, atmospheric Pb deposition recorded by peat cores in three minerogenic peat deposits from Switzerland. *Science of the Total Environment* 292(1-2), 19-31.
- Shotyk, W. & Noernberg, T. 2020. Sampling, handling, and preparation of peat cores from bogs: review of recent progress and perspectives for trace element research. *Canadian Journal of Soil Science* 100(4), 363-380
- Shotyk, W., Weiss, D., Appleby, P.G., Cheburkin, A.K., Frei, R., Gloor, M., Kramers, J.D., Reese, S., & Van Der Knaap, W.O. 1998. History of Atmospheric Lead Deposition Since 12,370 <sup>14</sup>C yr BP from a Peat Bog, Jura Mountains, Switzerland. *Science* 281(5383), 1635-1640.
- Shotyk, W., Krachler, M., Martinez-Cortizas, A., et al., 2002. A peat bog record of natural, pre-anthropogenic enrichments of trace elements in atmospheric aerosols since 12,370 <sup>14</sup>C yr BP, and their variation with Holocene climate change. *Earth and Planetary Sciences Letters* 199 (1-2), 21-37.
- Smith, H., Bobrov, A., & Lara, E. 2008. Diversity and biogeography of testate amoebae. *Biodiversity and Conservation* 17, 329-343.

Statistics Canada, Environment, Energy and Transportation Statistics Division (EETSD). 2016. Human Activity and the Environment: Freshwater in Canada. Statistics Canada Catalogue no. 16-201-X.

Steinmann, P., Huon, S., Roos-Barraclough, F., & Föllmi, K. 2006. A peat core based estimate of late-glacial and Holocene methane emissions from northern peatlands. *Global and Planetary Change* 53, 233–239.

Stocker, T.F., Qin, D., Plattner, G. –K. et al. 2013. Technical Summary. In: *Climate Change 2013: The Physical Science Basis. Contribution of Working Group I to the Fifth Assessment Report of the Intergovernmental Panel on Climate Change* (eds. Stocker, T.F., D. Qin, G.-K. Plattner, M. Tignor, S.K. Allen, J. Boschung, A. Nauels, Y. Xia, V. Bex and P.M. Midgley). Cambridge University Press, Cambridge, UK and New York, NY, USA, 33–115.

Swindles, G.T., Amesbury, M.J., Turner, T.E., et al. 2015. Evaluating the use of testate amoeba for palaeohydrological reconstruction in permafrost peatlands. *Palaeogeography, Palaeoclimatology, Palaeoecology* 424, 111-122.

Swindles, G.T., Galloway, J.M., Rushworth, G., Wheeler, J., Murphy, P., & Taylor, T.F. 2020. Natural to cultural: The vegetation history of the southern Yorkshire Dales, UK. *Review of Palaeobotany and Palynology*, 104328.

Tarnocai, C. 2006. The effect of climate change on carbon in Canadian peatlands. *Global and Planetary Change* 55, 222-232.

Tarnocai, C. 2013. The Impact of Climate Change on Canadian Peatlands. *Canadian Water Resources Journal* 34(4), 453-466.

Taylor, L.S., Swindles, G.T., Morris, P.J., & Gałka, M. 2019. Ecology of peatland testate amoebae in the Alaskan continuous permafrost zone. *Ecological Indicators* 96 Part 1, 153-162.

Tissot, B.P. & Welte, D.H. 1978. *Petroleum formation and occurrence: A new approach to oil and gas exploration*, Springer-Verlag.

Tolonen, K. 1986. Rhizopod analysis. In: *Handbook of Holocene Palaeoecology and Palaeohydrology* (ed. B.E. Berglund). Wiley, Chichester, 645-666.

Vaughan, D.G., J.C. Comiso, I. Allison, J. Carrasco, G. Kaser, R. Kwok, P. Mote, T. Murray, F. Paul, J. Ren, E. Rignot, O. Solomina, K. Steffen & T. Zhang. 2013. Observations: Cryosphere. In: *Climate Change 2013: The Physical Science Basis. Contribution of Working Group I to the Fifth Assessment Report of the Intergovernmental Panel on Climate Change* (eds. T.F. Stocker, D. Qin, G.-K. Plattner, M. Tignor, S.K. Allen, J. Boschung, A. Nauels, Y. Xia, V. Bex and P.M. Midgley). Cambridge University Press, Cambridge, UK and New York, NY, USA.

Vörösmarty, C., Hinzman, L., & Pundsack, J. 2008. Introduction to special section on changes in the Arctic freshwater system: identification, attribution, and impacts at local and global scales. *Journal of Geophysical Research – Biogeosciences* 113(G1), G01S91.

- Wanner, M. & Meisterfeld, R. 1994. Effects of some environmental factors on the shell morphology of testate amoebas (Rhizopoda, Protozoa). *European Journal of Protistology* 30, 191-195
- Weiss, D. Shotyk, W., Kramers, J.D., & Gloor, M. 1999. *Sphagnum* mosses as archives of recent and past atmospheric lead deposition in Switzerland. *Atmospheric Environment* 33(23), 3751-3763.
- Winton, M. 2006. Amplified Arctic climate change: What does surface albedo feedback have to do with it? *Geophysical Research Letters* 33(3), L03701, 1-4.
- Woo, M-K. & Thorne, R. 2003. Streamflow in the Mackenzie Basin, Canada. *Arctic* 56(4), 328-340.
- Woodland, W.A., Charman, D.J., & Sims, P.C. 1998. Quantitative estimates of water tables and soil moisture in Holocene peatlands from testate amoebae. *The Holocene* 8, 261-273.
- Yang, D., Shi, X., & Marsh, P. 2015. Variability and extreme of Mackenzie River daily discharge during 1973-2011. *Quaternary International* 380-381, 159-168.
- Yang, Z., Fang, W., Lu, X., Sheng, G.P., Graham, D.E., Liang, L., Wulschleger, S.D., & Gu, B. 2016. Warming increases methylmercury production in an Arctic soil. *Environmental Pollution* 214, 504-509.
- Yip, Q.K.Y., Burn, D.H., Seglenieks, F., Pietroniro, A., & Soulis, E.D. 2012. Climate Impacts on Hydrological Variables in the Mackenzie River Basin. *Canadian Water Resources Journal* 37(3), 209-230.
- Yu, Z., Loisel, J., Brosseau, D.P., Beilman, D.W., & Hunt, S.J. 2010. Global peatland dynamics since the Last Glacial Maximum. *Geophysical Research Letters* 37(13), L13402.



# APPENDICES

## Appendix A: Compilation of HAWK pyrolysis results

GSC Sample ID	Sample Name	Sample Information	Depth (m)	Sample Weight (mg)	TOC (%) Total Organic Carbon	Tmax (°C)	HI Hydrogen Index HC-mg/g TOC	OI Oxygen Index CO <sub>2</sub> -mg/g TsOC	S1 Free Oil HC-mg/g-rock	S2 Kerogen HC-mg/g-rock	S3C O <sub>2</sub> -mg-CO <sub>2</sub> /g-rock	S3C O-mg-CO/g-rock	S3' mg-CO <sub>2</sub> /g-rock	S3°C O-mg-CO/g-rock	S4C O <sub>2</sub> -mg-CO <sub>2</sub> /g-rock	S4C O-mg-CO/g-rock	S5 mg-CO <sub>2</sub> /g-rock	CC (%) Carbon Carbonate	CaCO <sub>3</sub> % Calcium carbonate equivalent	GOC (PC)% Generative Organic Carbon	NGOC (RC)% Non Generative Organic Carbon	AI Adsorption Index	PI Production Index	OSI Oil Saturation Index
C-638182	18GTA292 +1-0 cm		0.01	30.5	21.33	315	349	276	28.95	74.55	59.05	5.31	26.17	1.18	377.08	8.96	14.44	1.13	9.44	10.66	10.67	17.49	0.280	135
C-638183	18GTA292 0-1 cm		0.02	30.4	24.74	317	316	214	26.19	78.36	53.09	5.04	24.45	1.28	499.93	12.40	1.21	0.73	6.06	10.58	14.17	20.29	0.251	105
C-638184	18GTA292 1-2 cm		0.03	29.6	19.25	321	333	274	17.61	64.15	52.84	5.29	24.13	1.35	375.03	8.68	1.52	0.73	6.07	8.65	10.60	15.78	0.215	91
C-638184	18GTA292 1-2 cm	Duplicate	0.03	25.1	19.97	320	311	141	16.98	62.18	28.30	4.23	13.02	1.09	428.67	13.40	1.20	0.41	3.43	7.71	12.27	16.38	0.215	85
C-638185	18GTA292 2-3 cm		0.04	30.8	21.89	319	332	143	20.27	72.87	31.36	5.83	15.21	1.69	449.57	13.26	1.88	0.50	4.19	9.06	12.83	17.95	0.218	92
C-638186	18GTA292 3-4 cm		0.05	27.8	21.93	317	285	135	21.08	62.50	29.63	5.38	14.81	1.67	479.99	15.36	1.82	0.49	4.08	8.18	13.75	17.98	0.252	96
C-638187	18GTA292 4-5 cm		0.06	30.6	16.84	314	313	162	17.27	52.76	27.40	4.57	14.37	1.63	347.80	9.85	2.43	0.49	4.11	6.93	9.91	13.81	0.247	102
C-638188	18GTA292 5-6 cm		0.07	30.4	18.33	323	328	119	18.57	60.24	21.83	3.29	12.11	1.58	377.65	13.06	1.80	0.41	3.44	7.47	10.86	15.03	0.236	101
C-638189	18GTA292 6-7 cm		0.08	30.9	15.92	324	291	94	11.96	46.46	15.09	2.57	8.88	0.98	357.50	15.53	5.68	0.42	3.48	5.51	10.42	13.06	0.205	75
C-638190	18GTA292 7-8 cm		0.09	30.4	18.75	327	336	95	19.07	63.02	17.91	3.42	9.03	0.87	381.92	16.45	1.71	0.31	2.60	7.63	11.12	15.38	0.232	101
C-638191	18GTA292 8-9 cm		0.10	31.3	20.10	325	399	105	25.89	80.27	21.15	4.01	9.95	1.17	358.07	12.62	1.48	0.34	2.81	9.80	10.31	16.48	0.244	128
C-638192	18GTA292 9-10 cm		0.11	31.3	17.22	320	350	116	19.24	60.31	20.08	3.86	9.62	0.91	335.14	13.60	1.78	0.33	2.76	7.49	9.72	14.12	0.242	111
C-638193	18GTA292 10-11 cm		0.12	30.1	16.87	317	346	128	16.89	58.40	21.67	3.93	10.94	1.15	335.51	12.59	9.89	0.59	4.94	7.18	9.69	13.84	0.224	100
C-638194	18GTA292 11-12 cm		0.13	30.4	26.47	324	377	98	24.16	99.96	26.19	4.83	13.65	1.35	525.04	15.05	11.05	0.70	5.86	11.50	14.96	21.70	0.195	91
C-638195	18GTA292 12-13 cm		0.14	30.5	23.57	317	344	107	25.86	81.11	25.37	3.39	12.39	1.21	475.72	14.98	10.62	0.65	5.45	9.96	13.62	19.33	0.242	109
C-638196	18GTA292 13-14 cm		0.15	30.2	21.99	317	340	110	24.65	74.81	24.27	3.55	11.87	0.94	438.38	17.50	10.43	0.63	5.24	9.29	12.71	18.04	0.248	112
C-638197	18GTA292 14-15 cm		0.16	30.6	17.89	323	335	93	16.32	60.07	16.73	2.25	9.42	0.96	373.21	15.04	6.88	0.47	3.88	7.07	10.82	14.67	0.214	91
C-638198	18GTA79 +1-0 cm		0.01	30.1	21.17	316	450	136	34.12	95.43	28.92	3.43	12.68	0.83	322.00	13.70	9.97	0.74	6.14	11.96	9.21	17.36	0.263	161
C-638199	18GTA79 0-1 cm		0.02	31.8	16.38	313	401	167	24.13	65.78	27.36	2.87	15.88	1.92	272.50	9.19	1.73	0.52	4.34	8.55	7.83	13.43	0.268	147
C-638200	18GTA79 1-2 cm		0.03	30.5	13.36	318	464	218	23.29	62.09	29.20	2.73	16.45	2.78	176.09	7.69	2.56	0.58	4.82	8.23	5.13	10.96	0.273	174
C-638201	18GTA79 2-3 cm		0.04	31.4	17.24	323	489	141	31.07	84.38	24.46	2.65	12.19	1.94	227.12	9.57	2.04	0.43	3.58	10.64	6.60	14.14	0.269	180
C-638202	18GTA79 3-4 cm		0.05	30.8	18.63	323	433	114	26.25	80.72	21.40	2.56	11.27	1.23	302.47	13.34	34.31	1.27	10.58	9.81	8.82	15.28	0.245	140
C-638203	18GTA79 4-5 cm		0.06	29.9	25.77	323	370	98	30.70	95.43	25.51	3.67	11.53	0.79	493.47	16.91	10.08	0.61	5.05	11.59	14.18	21.13	0.243	119
C-638204	18GTA79 5-6 cm		0.07	30.5	20.02	323	450	116	29.38	90.21	23.38	3.44	10.70	0.78	314.08	11.28	1.61	0.35	2.94	10.97	9.05	16.41	0.246	146
C-638205	18GTA79 6-7 cm		0.08	30.4	22.75	321	395	108	32.31	89.92	24.62	3.38	11.30	1.33	398.45	15.05	1.75	0.38	3.20	11.23	11.51	18.65	0.264	142
C-638206	18GTA79 7-8 cm		0.09	31.9	20.03	320	437	114	29.20	87.61	22.93	3.33	11.18	0.83	324.89	10.68	1.39	0.36	3.01	10.71	9.32	16.43	0.250	145



















C-638173	Mac S4 55F		0.53	26.8	18.87	315	305	110	16.4 4	57.73	20.86	1.16	14.1 3	1.34	408.7 8	18.0 2	6.66	0.60	4.97	6.95	11.92	15.48	0.222	87
C-638174	Mac S4 56F		0.54	19.6	24.51	319	297	137	22.8 0	72.87	33.73	1.77	21.4 3	2.34	531.3 1	19.7 3	20.5 3	1.19	9.96	9.18	15.34	20.10	0.238	93
C-638175	Mac S4 57F		0.55	25.8	21.77	318	297	143	20.9 2	64.70	31.19	1.86	20.0 8	2.00	472.2 8	14.9 5	18.4 3	1.09	9.11	8.25	13.52	17.85	0.244	96
C-638176	Mac S4 58		0.56	26.1	21.79	317	267	120	18.3 4	58.31	26.35	1.39	17.3 3	1.80	504.0 7	16.5 8	16.1 3	0.95	7.92	7.33	14.46	17.87	0.239	84
C-638177	Mac S4 59		0.57	20.4	25.13	325	532	104	44.4 3	133.81	26.33	2.15	12.1 9	1.68	313.9 3	13.3 3	8.52	0.60	5.01	16.00	9.13	20.61	0.249	176
C-638178	Mac S4 60		0.58	26.8	25.11	320	240	145	19.5 6	60.31	36.48	1.98	23.3 0	2.31	602.0 6	17.9 0	26.8 8	1.42	11.82	7.92	17.19	20.59	0.245	77
C-638179	Mac S4 61		0.59	20.1	22.44	317	265	147	19.0 0	59.64	33.07	1.62	21.2 3	2.29	512.0 6	17.9 7	24.5 9	1.30	10.82	7.70	14.74	18.40	0.242	84
C-638180	Mac S4 62		0.60	28.9	16.75	315	302	194	16.1 2	50.73	32.53	1.68	21.7 9	2.17	350.2 1	11.7 9	19.7 3	1.18	9.82	6.69	10.06	13.73	0.241	96
C-638181	Mac S4 63		0.61	20.0	17.69	318	360	219	20.9 2	63.82	38.77	2.41	23.9 4	2.62	316.5 4	14.9 3	27.0 0	1.45	12.05	8.42	9.27	14.51	0.247	118

**Appendix B: Table of GSC curation numbers (C-#), core labels and depths, and facilities used for analyses of sub-samples.**

Core	Samples	GSC Curation (C-) number	Sample Name	Depth (cm)	Plant macrofossils	<sup>14</sup> C	<sup>210</sup> Pb	Palynology	Testate Amoebae	Hg	ICP-MS	Carbon Isotope	HAWK Pyrolysis
16PS1	1	C-638212	16PS1 0-5 mm	0-0.5		QUB		GSC Calgary	Carleton University	GSC Atlantic		MMU	GSC Calgary
	2	C-638213	16PS1 5-10 mm	0.5-1									
	3	C-638214	16PS1 10-15 mm	1-1.5									
	4	C-638215	16PS1 15-20 mm	1.5-2									
	5	C-638216	16PS1 20-25 mm	2-2.5									
	6	C-638217	16PS1 25-30 mm	2.5-3									
	7	C-638218	16PS1 30-35 mm	3-3.5									
	8	C-638219	16PS1 35-40 mm	3.5-4									
	9	C-638220	16PS1 40-45 mm	4-4.5		QUB							
	10	C-638221	16PS1 45-50 mm	4.5-5									
	11	C-638222	16PS1 50-55 mm	5-5.5									
	12	C-638223	16PS1 55-60 mm	5.5-6									
	13	C-638224	16PS1 60-65 mm	6-6.5									
	14	C-638225	16PS1 65-70 mm	6.5-7									
	15	C-638226	16PS1 70-75 mm	7-7.5									
	16	C-638227	16PS1 75-80 mm	7.5-8									
	17	C-638228	16PS1 80-85 mm	8-8.5		QUB							

18	C-638229	16PS1 85-90 mm	8.5-9						
19	C-638230	16PS1 90-95 mm	9-9.5						
20	C-638231	16PS1 95-100 mm	9.5-10						
21	C-638232	16PS1 100-105 mm	10-10.5						
22	C-638233	16PS1 105-110 mm	10.5-11						
23	C-638234	16PS1 110-115 mm	11-11.5						
24	C-638235	16PS1 115-120 mm	11.5-12			QUB			
25	C-638236	16PS1 120-125 mm	12-12.5						
26	C-638237	16PS1 125-130 mm	12.5-13						
27	C-638238	16PS1 130-135 mm	13-13.5						
28	C-638239	16PS1 135-140 mm	13.5-14						
29	C-638240	16PS1 140-145 mm	14-14.5						
30	C-638241	16PS1 145-150 mm	14.5-15						
31	C-638242	16PS1 150-155 mm	15-15.5						
32	C-638243	16PS1 155-160 mm	15.5-16						
33	C-638244	16PS1 160-165 mm	16-16.5			QUB			
34	C-638245	16PS1 165-170 mm	16.5-17						
35	C-638246	16PS1 170-175 mm	17-17.5						
36	C-638247	16PS1 175-180 mm	17.5-18						
37	C-638248	16PS1 180-185 mm	18-18.5						
38	C-638249	16PS1 185-190 mm	18.5-19						
39	C-638250	16PS1 190-195 mm	19-19.5						
40	C-638251	16PS1 195-200 mm	19.5-20						
41	C-638252	16PS1 200-205 mm	20-20.5			QUB			
42	C-638253	16PS1 205-210 mm	20.5-21						
43	C-638254	16PS1 210-215 mm	21-21.5						
44	C-638255	16PS1 215-220 mm	21.5-22						
45	C-638256	16PS1 220-225 mm	22-22.5						
46	C-638257	16PS1 225-230 mm	22.5-23						
47	C-638258	16PS1 230-235 mm	23-23.5						
48	C-638259	16PS1 235-240 mm	23.5-24						
49	C-638260	16PS1 240-245 mm	24-24.5			QUB			
50	C-638261	16PS1 245-250 mm	24.5-25						
51	C-638262	16PS1 250-255 mm	25-25.5						

	52	C-638263	16PS1 255-260 mm	25.5-26									
	53	C-638264	16PS1 260-265 mm	26-26.5									
	54	C-638265	16PS1 265-270 mm	26.5-27									
	55	C-638266	16PS1 270-275 mm	27-27.5									
	56	C-638267	16PS1 275-280 mm	27.5-28									
	57	C-638268	16PS1 280-285 mm	28-28.5			QUB						
	58	C-638269	16PS1 285-290 mm	28.5-29									
	59	C-638270	16PS1 290-295 mm	29-29.5									
	60	C-638271	16PS1 295-300 mm	29.5-30									
	61	C-638272	16PS1 300-305 mm	30-30.5			QUB					No material remaining	
	62	C-638273	16PS1 305-310 mm	30.5-31								No material remaining	
	63	C-638274	16PS1 310-315 mm	31-31.5								No material remaining	No material remaining
	16PS2	1	C-638275	16PS2 0-5 mm	0-0.5								
2		C-638276	16PS2 5-10 mm	0.5-1									
3		C-638277	16PS2 10-15 mm	1-1.5			AEL AMS						
4		C-638278	16PS2 15-20 mm	1.5-2									
5		C-638279	16PS2 20-25 mm	2-2.5									
6		C-638280	16PS2 25-30 mm	2.5-3									
7		C-638281	16PS2 30-35 mm	3-3.5									
8		C-638282	16PS2 35-40 mm	3.5-4									
9		C-638283	16PS2 40-45 mm	4-4.5									
10		C-638284	16PS2 45-50 mm	4.5-5									
11		C-638285	16PS2 50-55 mm	5-5.5									
12		C-638286	16PS2 55-60 mm	5.5-6			AEL AMS						
13		C-638287	16PS2 60-65 mm	6-6.5									

14	C-638288	16PS2 65-70 mm	6.5-7						
15	C-638289	16PS2 70-75 mm	7-7.5						
16	C-638290	16PS2 75-80 mm	7.5-8						
17	C-638291	16PS2 80-85 mm	8-8.5						
18	C-638292	16PS2 85-90 mm	8.5-9						
19	C-638293	16PS2 90-95 mm	9-9.5						
20	C-638294	16PS2 95-100 mm	9.5-10						
21	C-638295	16PS2 100-105 mm	10-10.5						
22	C-638296	16PS2 105-110 mm	10.5-11						
23	C-638297	16PS2 110-115 mm	11-11.5		AEL AMS				
24	C-638298	16PS2 115-120 mm	11.5-12						
25	C-638299	16PS2 120-125 mm	12-12.5						
26	C-638300	16PS2 125-130 mm	12.5-13						
27	C-638301	16PS2 130-135 mm	13-13.5						
28	C-638302	16PS2 135-140 mm	13.5-14						
29	C-638303	16PS2 140-145 mm	14-14.5						
30	C-638304	16PS2 145-150 mm	14.5-15						
31	C-638305	16PS2 150-155 mm	15-15.5						
32	C-638306	16PS2 155-160 mm	15.5-16						
33	C-638307	16PS2 160-165 mm	16-16.5						
34	C-638308	16PS2 165-170 mm	16.5-17		AEL AMS				
35	C-638309	16PS2 170-175 mm	17-17.5						
36	C-638310	16PS2 175-180 mm	17.5-18						
37	C-638311	16PS2 180-185 mm	18-18.5						
38	C-638312	16PS2 185-190 mm	18.5-19						
39	C-638313	16PS2 190-195 mm	19-19.5						
40	C-638314	16PS2 195-200 mm	19.5-20						
41	C-638315	16PS2 200-205 mm	20-20.5						
42	C-638316	16PS2 205-210 mm	20.5-21						
43	C-638317	16PS2 210-215 mm	21-21.5						
44	C-638318	16PS2 215-220 mm	21.5-22		AEL AMS				
45	C-638319	16PS2 220-225 mm	22-22.5						
46	C-638320	16PS2 225-230 mm	22.5-23						
47	C-638321	16PS2 230- 235 mm	23-23.5						

	48	C-638322	16PS2 235-240 mm	23.5-24									
	49	C-638323	16PS2 240-245 mm	24-24.5									
	50	C-638324	16PS2 245-250 mm	24.5-25									
	51	C-638325	16PS2 250-255 mm	25-25.5									
	52	C-638326	16PS2 255-260 mm	25.5-26									
	53	C-638327	16PS2 260-265 mm	26-26.5									
	54	C-638328	16PS2 265-270 mm	26.5-27									
	55	C-638329	16PS2 270-275 mm	27-27.5									
	56	C-638330	16PS2 275-280 mm	27.5-28									
	57	C-638331	16PS2 280-285 mm	28-28.5									
	58	C-638332	16PS2 285-290 mm	28.5-29			AEL AMS						
	59	C-638333	16PS2 290-295 mm	29-29.5									
18-GTA-79	1	C-638198	18GTA79 +1-0 cm	Living Layer								SWAMP	GSC Calgary
	2	C-638199	18GTA79 0-1 cm	0-1			QUB					SWAMP	
	3	C-638200	18GTA79 1-2 cm	1-2								SWAMP	
	4	C-638201	18GTA79 2-3 cm	2-3								SWAMP	
	5	C-638202	18GTA79 3-4 cm	3-4								SWAMP	
	6	C-638203	18GTA79 4-5 cm	4-5			QUB					SWAMP	
	7	C-638204	18GTA79 5-6 cm	5-6								SWAMP	
	8	C-638205	18GTA79 6-7 cm	6-7								SWAMP	
	9	C-638206	18GTA79 7-8 cm	7-8								SWAMP	
	10	C-638207	18GTA79 8-9 cm	8-9			QUB					SWAMP	
	11	C-638208	18GTA79 9-10 cm	9-10								SWAMP	
	12	C-638209	18GTA79 10-11 cm	10-11								SWAMP + Duplicate	
	13	C-638210	18GTA79 11-12 cm	11-12								SWAMP	
	14	C-638211	18GTA79 12-13 cm	12-13			QUB					SWAMP + Duplicate	
18-GTA-292	1	C-638182	18GTA292 +1-0 cm	Living Layer									GSC Calgary
	2	C-638183	18GTA292 0-1 cm	0-1			QUB					SWAMP	
	3	C-638184	18GTA292 1-2 cm	1-2									

	4	C-638185	18GTA292 2-3 cm	2-3									
	5	C-638186	18GTA292 3-4 cm	3-4									
	6	C-638187	18GTA292 4-5 cm	4-5									
	7	C-638188	18GTA292 5-6 cm	5-6									
	8	C-638189	18GTA292 6-7 cm	6-7									
	9	C-638190	18GTA292 7-8 cm	7-8									
	10	C-638191	18GTA292 8-9 cm	8-9									
	11	C-638192	18GTA292 9-10 cm	9-10									
	12	C-638193	18GTA292 10-11 cm	10-11									
	13	C-638194	18GTA292 11-12 cm	11-12									
	14	C-638195	18GTA292 12-13 cm	12-13									
	15	C-638196	18GTA292 13-14 cm	13-14									
	16	C-638197	18GTA292 14-15 cm	14-15									
	1	C-637905	Mac S1 1F	Living Layer								SWAMP	
	2	C-637906	Mac S1 2F	0-1								SWAMP	
	3	C-637907	Mac S1 3F	1-2								SWAMP	
	4	C-637908	Mac S1 4F	2-3								SWAMP	
	5	C-637909	Mac S1 5F	3-4									
	6	C-637910	Mac S1 6F	4-5								SWAMP	
	7	C-637911	Mac S1 7F	5-6									
	8	C-637912	Mac S1 8F	6-7								SWAMP	
	9	C-637913	Mac S1 9F	7-8									
	10	C-637914	Mac S1 10F	8-9								SWAMP	
	11	C-637915	Mac S1 11F	9-10									
	12	C-637916	Mac S1 12F	10-11								SWAMP	
	13	C-637917	Mac S1 13F	11-12									
	14	C-637918	Mac S1 14F	12-13								SWAMP	
	15	C-637919	Mac S1 15F	13-14									
	16	C-637920	Mac S1 16F	14-15								SWAMP	
	17	C-637921	Mac S1 17F	15-16									
	18	C-637922	Mac S1 18F	16-17								SWAMP	
	19	C-637923	Mac S1 19F	17-18									
	20	C-637924	Mac S1 20F	18-19								SWAMP	
	21	C-637925	Mac S1 21F	19-20									

22	C-637926	Mac S1 22F	20-21							SWAMP	
23	C-637927	Mac S1 23F	21-22								
24	C-637928	Mac S1 24F	22-23							SWAMP	
25	C-637929	Mac S1 25F	23-24			AEL AMS					
26	C-637930	Mac S1 26F	24-25							SWAMP	
27	C-637931	Mac S1 27F	25-26								
28	C-637932	Mac S1 28F	26-27							SWAMP	
29	C-637933	Mac S1 29F	27-28								
30	C-637934	Mac S1 30F	28-29							SWAMP	
31	C-637935	Mac S1 31F	29-30								
32	C-637936	Mac S1 32F	30-31							SWAMP	
33	C-637937	Mac S1 33F	31-32			AEL AMS					
34	C-637938	Mac S1 34F	32-33							SWAMP	
35	C-637939	Mac S1 35F	33-34								
36	C-637940	Mac S1 36F	34-35							SWAMP	
37	C-637941	Mac S1 37F	35-36								
38	C-637942	Mac S1 38F	36-37							SWAMP	
39	C-637943	Mac S1 39F	37-38								
40	C-637944	Mac S1 40F	38-39							SWAMP	
41	C-637945	Mac S1 41F	39-40			AEL AMS					
42	C-637946	Mac S1 42F	40-41							SWAMP	
43	C-637947	Mac S1 43F	41-42								
44	C-637948	Mac S1 44F	42-43							SWAMP	
45	C-637949	Mac S1 45F	43-44								
46	C-637950	Mac S1 46F	44-45							SWAMP	
47	C-637951	Mac S1 47F	45-46								
48	C-637952	Mac S1 48F	46-47							SWAMP	
49	C-637953	Mac S1 49F	47-48			AEL AMS					
50	C-637954	Mac S1 50F	48-49							SWAMP	
51	C-637955	Mac S1 51F	49-50								
52	C-637956	Mac S1 52F	50-51							SWAMP	
53	C-637957	Mac S1 53F	51-52								
54	C-637958	Mac S1 54F	52-53							SWAMP	
55	C-637959	Mac S1 55F	53-54								



	56	C-637960	Mac S1 56F	54-55							SWAMP		
	57	C-637961	Mac S1 57F	55-56							SWAMP		
MAC S2	1	C-637962	Mac S2 1F	Living Layer	University of Łódź		SWAMP	GSC Calgary	Carleton University	GSC Atlantic		SWAMP	GSC Calgary
	2	C-637963	Mac S2 2F	0-1		AEL AMS					SWAMP		
	3	C-637964	Mac S2 3F	1-2							SWAMP		
	4	C-637965	Mac S2 4F	2-3							SWAMP		
	5	C-637966	Mac S2 5F	3-4									
	6	C-637967	Mac S2 6F	4-5							SWAMP		
	7	C-637968	Mac S2 7F	5-6									
	8	C-637969	Mac S2 8F	6-7							SWAMP		
	9	C-637970	Mac S2 9F	7-8									
	10	C-637971	Mac S2 10F	8-9							SWAMP		
	11	C-637972	Mac S2 11F	9-10									
	12	C-637973	Mac S2 12F	10-11							SWAMP		
	13	C-637974	Mac S2 13F	11-12		AEL AMS							
	14	C-637975	Mac S2 14F	12-13							SWAMP		
	15	C-637976	Mac S2 15F	13-14									
	16	C-637977	Mac S2 16F	14-15							SWAMP		
	17	C-637978	Mac S2 17F	15-16									
	18	C-637979	Mac S2 18F	16-17							SWAMP		
	19	C-637980	Mac S2 19F	17-18									
	20	C-637981	Mac S2 20F	18-19							SWAMP		
	21	C-637982	Mac S2 21F	19-20									
	22	C-637983	Mac S2 22F	20-21							SWAMP		
	23	C-637984	Mac S2 23F	21-22		AEL AMS							
	24	C-637985	Mac S2 24F	22-23							SWAMP		
	25	C-637986	Mac S2 25F	23-24									
	26	C-637987	Mac S2 26F	24-25							SWAMP		
	27	C-637988	Mac S2 27F	25-26									
	28	C-637989	Mac S2 28F	26-27							SWAMP		
	29	C-637990	Mac S2 29F	27-28									
	30	C-637991	Mac S2 30F	28-29							SWAMP		
	31	C-637992	Mac S2 31F	29-30									
	32	C-637993	Mac S2 32F	30-31							SWAMP		

33	C-637994	Mac S2 33F	31-32								
34	C-637995	Mac S2 34F	32-33		AEL AMS					SWAMP	
35	C-637996	Mac S2 35F	33-34								
36	C-637997	Mac S2 36F	34-35							SWAMP	
37	C-637998	Mac S2 37F	35-36								
38	C-637999	Mac S2 38F	36-37							SWAMP	
39	C-638000	Mac S2 39F	37-38								
40	C-638001	Mac S2 40F	38-39							SWAMP	
41	C-638002	Mac S2 41F	39-40								
42	C-638003	Mac S2 42F	40-41							SWAMP	
43	C-638004	Mac S2 43F	41-42								
44	C-638005	Mac S2 44F	42-43							SWAMP	
45	C-638006	Mac S2 45F	43-44		AEL AMS						
46	C-638007	Mac S2 46F	44-45							SWAMP	
47	C-638008	Mac S2 47F	45-46								
48	C-638009	Mac S2 48F	46-47							SWAMP	
49	C-638010	Mac S2 49F	47-48								
50	C-638011	Mac S2 50F	48-49							SWAMP	
51	C-638012	Mac S2 51F	49-50								
52	C-638013	Mac S2 52F	50-51							SWAMP	
53	C-638014	Mac S2 53F	51-52								
54	C-638015	Mac S2 54F	52-53							SWAMP	
55	C-638016	Mac S2 55F	53-54								
56	C-638017	Mac S2 56F	54-55		AEL AMS					SWAMP	
57	C-638018	Mac S2 57F	55-56								
58	C-638019	Mac S2 58	56-57							SWAMP	
59	C-638020	Mac S2 59	57-58								
60	C-638021	Mac S2 60	58-59							SWAMP	
61	C-638022	Mac S2 61	59-60								
62	C-638023	Mac S2 62	60-61							SWAMP	
63	C-638024	Mac S2 63	61-62								
64	C-638025	Mac S2 64	62-63							SWAMP	
65	C-638026	Mac S2 65	63-64								
66	C-638027	Mac S2 66	64-65							SWAMP	

	67	C-638028	Mac S2 67	65-66		AEL AMS							
	68	C-638029	Mac S2 68	66-67								SWAMP	
	69	C-638030	Mac S2 69	67-68									
	70	C-638031	Mac S2 70	68-69								SWAMP	
	71	C-638032	Mac S2 71	69-70									
	72	C-638033	Mac S2 72	70-71								SWAMP	
	73	C-638034	Mac S2 73	71-72									
	74	C-638035	Mac S2 74	72-73								SWAMP	
	75	C-638036	Mac S2 75	73-74									
	76	C-638037	Mac S2 76	74-75								SWAMP	
	77	C-638038	Mac S2 77	75-76									
	78	C-638039	Mac S2 78	76-77								SWAMP	
	79	C-638040	Mac S2 79	77-78		QUB						SWAMP	
MAC S3	1	C-638041	Mac S3 1F	Living Layer	University of Łódź		SWAMP	GSC Calgary	Carleton University	GSC Atlantic		SWAMP	GSC Calgary
	2	C-638042	Mac S3 2F	0-1		QUB						SWAMP	
	3	C-638043	Mac S3 3F	1-2								SWAMP	
	4	C-638044	Mac S3 4F	2-3								SWAMP	
	5	C-638045	Mac S3 5F	3-4									
	6	C-638046	Mac S3 6F	4-5								SWAMP	
	7	C-638047	Mac S3 7F	5-6									
	8	C-638048	Mac S3 8F	6-7		QUB						SWAMP	
	9	C-638049	Mac S3 9F	7-8									
	10	C-638050	Mac S3 10F	8-9								SWAMP	
	11	C-638051	Mac S3 11F	9-10									
	12	C-638052	Mac S3 12F	10-11								SWAMP	
	13	C-638053	Mac S3 13F	11-12									
	14	C-638054	Mac S3 14F	12-13								SWAMP	
15	C-638055	Mac S3 15F	13-14										
16	C-638056	Mac S3 16F	14-15			SWAMP							
17	C-638057	Mac S3 17F	15-16										
18	C-638058	Mac S3 18F	16-17			SWAMP							
19	C-638059	Mac S3 19F	17-18										
20	C-638060	Mac S3 20F	18-19		QUB		SWAMP						
21	C-638061	Mac S3 21F	19-20										

22	C-638062	Mac S3 22F	20-21							SWAMP	
23	C-638063	Mac S3 23F	21-22								
24	C-638064	Mac S3 24F	22-23							SWAMP	
25	C-638065	Mac S3 25F	23-24								
26	C-638066	Mac S3 26F	24-25							SWAMP	
27	C-638067	Mac S3 27F	25-26								
28	C-638068	Mac S3 28F	26-27							SWAMP	
29	C-638069	Mac S3 29F	27-28								
30	C-638070	Mac S3 30F	28-29							SWAMP	
31	C-638071	Mac S3 31F	29-30								
32	C-638072	Mac S3 32F	30-31							SWAMP	
33	C-638073	Mac S3 33F	31-32								
34	C-638074	Mac S3 34F	32-33							SWAMP	
35	C-638075	Mac S3 35F	33-34								
36	C-638076	Mac S3 36F	34-35							SWAMP	
37	C-638077	Mac S3 37F	35-36								
38	C-638078	Mac S3 38F	36-37							SWAMP	
39	C-638079	Mac S3 39F	37-38								
40	C-638080	Mac S3 40F	38-39							SWAMP	
41	C-638081	Mac S3 41F	39-40								
42	C-638082	Mac S3 42F	40-41							SWAMP	
43	C-638083	Mac S3 43F	41-42								
44	C-638084	Mac S3 44F	42-43							SWAMP	
45	C-638085	Mac S3 45F	43-44								
46	C-638086	Mac S3 46F	44-45							SWAMP	
47	C-638087	Mac S3 47F	45-46								
48	C-638088	Mac S3 48F	46-47							SWAMP	
49	C-638089	Mac S3 49F	47-48								
50	C-638090	Mac S3 50F	48-49							SWAMP	
51	C-638091	Mac S3 51F	49-50								
52	C-638092	Mac S3 52F	50-51							SWAMP	
53	C-638093	Mac S3 53F	51-52								
54	C-638094	Mac S3 54F	52-53							SWAMP	
55	C-638095	Mac S3 55F	53-54								

	56	C-638096	Mac S3 56F	54-55							SWAMP						
	57	C-638097	Mac S3 57F	55-56													
	58	C-638098	Mac S3 58	56-57		QUB					SWAMP						
	59	C-638099	Mac S3 59	57-58													
	60	C-638100	Mac S3 60	58-59							SWAMP						
	61	C-638101	Mac S3 61	59-60													
	62	C-638102	Mac S3 62	60-61							SWAMP						
	63	C-638103	Mac S3 63	61-62													
	64	C-638104	Mac S3 64	62-63							SWAMP						
	65	C-638105	Mac S3 65	63-64													
	66	C-638106	Mac S3 66	64-65							SWAMP						
	67	C-638107	Mac S3 67	65-66													
	68	C-638108	Mac S3 68	66-67		QUB					SWAMP						
	69	C-638109	Mac S3 69	67-68													
	70	C-638110	Mac S3 70	68-69							SWAMP						
	71	C-638111	Mac S3 71	69-70													
	72	C-638112	Mac S3 72	70-71							SWAMP						
	73	C-638113	Mac S3 73	71-72													
	74	C-638114	Mac S3 74	72-73							SWAMP						
	75	C-638115	Mac S3 75	73-74													
	76	C-638116	Mac S3 76	74-75							SWAMP						
	77	C-638117	Mac S3 77	75-76													
	78	C-638118	Mac S3 78	76-77		QUB					SWAMP						
MAC S4	1	C-638119	Mac S4 1F	Living Layer	University of Łódź		SWAMP	GSC Calgary	Carleton University	GSC Atlantic	SWAMP	GSC Calgary					
	2	C-638120	Mac S4 2F	0-1												SWAMP	
	3	C-638121	Mac S4 3F	1-2		AEL AMS										SWAMP	
	4	C-638122	Mac S4 4F	2-3												SWAMP	
	5	C-638123	Mac S4 5F	3-4													
	6	C-638124	Mac S4 6F	4-5												SWAMP	
	7	C-638125	Mac S4 7F	5-6													
	8	C-638126	Mac S4 8F	6-7												SWAMP	
	9	C-638127	Mac S4 9F	7-8													
	10	C-638128	Mac S4 10F	8-9												SWAMP	
	11	C-638129	Mac S4 11F	9-10													

12	C-638130	Mac S4 12F	10-11								SWAMP	
13	C-638131	Mac S4 13F	11-12		AEL AMS							
14	C-638132	Mac S4 14F	12-13								SWAMP	
15	C-638133	Mac S4 15F	13-14									
16	C-638134	Mac S4 16F	14-15								SWAMP	
17	C-638135	Mac S4 17F	15-16									
18	C-638136	Mac S4 18F	16-17								SWAMP	
19	C-638137	Mac S4 19F	17-18									
20	C-638138	Mac S4 20F	18-19								SWAMP	
21	C-638139	Mac S4 21F	19-20									
22	C-638140	Mac S4 22F	20-21								SWAMP	
23	C-638141	Mac S4 23F	21-22		AEL AMS							
24	C-638142	Mac S4 24F	22-23								SWAMP	
25	C-638143	Mac S4 25F	23-24									
26	C-638144	Mac S4 26F	24-25								SWAMP	
27	C-638145	Mac S4 27F	25-26									
28	C-638146	Mac S4 28F	26-27								SWAMP	
29	C-638147	Mac S4 29F	27-28									
30	C-638148	Mac S4 30F	28-29								SWAMP	
31	C-638149	Mac S4 31F	29-30									
32	C-638150	Mac S4 32F	30-31								SWAMP	
33	C-638151	Mac S4 33F	31-32		AEL AMS							
34	C-638152	Mac S4 34F	32-33								SWAMP	
35	C-638153	Mac S4 35F	33-34									
36	C-638154	Mac S4 36F	34-35								SWAMP	
37	C-638155	Mac S4 37F	35-36									
38	C-638156	Mac S4 38F	36-37								SWAMP	
39	C-638157	Mac S4 39F	37-38									
40	C-638158	Mac S4 40F	38-39								SWAMP	
41	C-638159	Mac S4 41F	39-40									
42	C-638160	Mac S4 42F	40-41								SWAMP	
43	C-638161	Mac S4 43F	41-42		AEL AMS							
44	C-638162	Mac S4 44F	42-43								SWAMP	
45	C-638163	Mac S4 45F	43-44									

46	C-638164	Mac S4 46F	44-45								SWAMP	
47	C-638165	Mac S4 47F	45-46									
48	C-638166	Mac S4 48F	46-47								SWAMP	
49	C-638167	Mac S4 49F	47-48									
50	C-638168	Mac S4 50F	48-49								SWAMP	
51	C-638169	Mac S4 51F	49-50									
52	C-638170	Mac S4 52F	50-51								SWAMP	
53	C-638171	Mac S4 53F	51-52									
54	C-638172	Mac S4 54F	52-53								SWAMP	
55	C-638173	Mac S4 55F	53-54									
56	C-638174	Mac S4 56F	54-55								SWAMP	
57	C-638175	Mac S4 57F	55-56									
58	C-638176	Mac S4 58	56-57								SWAMP	
59	C-638177	Mac S4 59	57-58									
60	C-638178	Mac S4 60	58-59								SWAMP	
61	C-638179	Mac S4 61	59-60									
62	C-638180	Mac S4 62	60-61								SWAMP	
63	C-638181	Mac S4 63	61-62								SWAMP	